

SBC-GPC3 USER MANUAL



SBC-GPC3 User Manual

Part Number 1E-04-00-0129

© 2007 American Auto-Matrix™

This document is protected by copyright and is the attribute of American Auto-Matrix. It may not be used or copied in whole or in part for any purpose other than that for which it is supplied without authorization. This document does not constitute any warranty, expressed or implied.

Every effort has been made to ensure that all information was correct at the time of publication. American Auto-Matrix reserves the right to alter specifications, performance, capabilities and presentation of this product at any time.

American Auto-Matrix and Auto-Matrix are trademarks of American Auto-Matrix and are not to be used for publication without the written consent of American Auto-Matrix.

All other brand names or product names are trademarks or registered trademarks of their respective companies or organizations.

WORLD HEADQUARTERS

American Auto-Matrix
One Technology Lane
Export, Pennsylvania 15632-8903 USA
Tel (1) 724-733-2000
Fax (1) 724-327-6124
Email aam@aamatrix.com
www.aamatrix.com

Updated 6/29/07

Updated Remote I/O portion of §2 to discuss STAT Display Sequence limits on loaded STATbus networks.

Updated 3/16/07

- ▼ Corresponds to v1.30 series firmware
- ▼ Document uses new date revision scheme for Technical Documentation
- ▼ §3.15.1 Added Zone Scheduling Feature
- ▼ Fixed various bit position errors in bitmap definitions through user documentation
- ▼ Appendix A - Added Zone Scheduling attributes to F900 Schedule Summary Channel

Version 1.1

(Corresponds to firmware version 1.04)

- ▼ §1.5.3 - Revised power requirements to match changes in PTC circuits.
- ▼ Revised §2.2.2 to reflect changes in PTC values and explain power supply options.
- ▼ §3.1.1 - Corrected FF00;**FT**.
- ▼ §3 and App. A - Added attributes FF00;**DS, RD, RM, ND, NM, ST**, and **ET** to control Daylight Savings.
- ▼ §3 and App. A - Added descriptions for FF00;**FC**
- ▼ §3 and App. A - Added SMARTStat 1-12 options for FExx;**SM**.
- ▼ §3 and App. A - Added descriptions for FA1x;**CV**.
- ▼ §3 and App. A - Corrected descriptions of FB0x;**FT, NT**, FA0x;**RA**, FA1x;**OB**, FA2x;**RA**, F90x;**AO**, F30x;**AV, HV, LV**, F200;**\$1, \$2, \$3, \$4, \$5, \$6, \$7, \$8**, F20x;**\$\$**.
- ▼ §2.4.2 Added Note regarding FE3x;**MD** and counting run hours.
- ▼ §3.1.4 - Added Note regarding broadcasting alarms/polling for alarms.

Version 1.0 - Initial Manual Release

This manual describes the installation and operation of the American Auto-Matrix SBC-GPC3 controller.

This document is divided into the following sections:

- ▼ One: Overview, describing the features of the SBC-GPC3 and presenting the specifications for the controller
- ▼ Two: Wiring, Installation & Usage, detailing the wiring and installation procedures as well as configuration information
- ▼ Three: Channel & Attribute Descriptions, listing all attributes present in each channel in the controller and describing their use
- ▼ Four: SBC-STAT Features, explaining the configuration and use of the menus and options on the SBC-STAT
- ▼ Five: SPL Support, giving a brief overview of SPL and how SPL programs are used by the SBC-GPC3
- ▼ Appendix A: Channels & Attributes, enumerating the attributes in every channel along with their datatype, access, storage and default values (if any)
- ▼ Appendix B: SPL Error Codes, describing the error codes that may be encountered when working with SPL programs
- ▼ Appendix C: PUP Datatypes, listing the hexadecimal and decimal PUP numeric data type codes

This document contains certain style and formatting conventions for conveying information in a clear and concise manner:

- ▼ Attribute names are shown in **bold**. For example: **CV**.
- ▼ Attribute with the associated channel specified are listed with the channel followed by a semicolon and then the attribute. For example: FE01; **CV**.
- ▼ Menu commands appear with a ">" symbol between levels. For example: File>Open.
- ▼ *Italics* indicate a section of this manual or another publication.
- ▼ The following formats are used to highlight important information:

NOTE

Notes indicate important information and appear in boxes with this format separated from the running text.

CAUTION

Cautions indicate information that may prevent serious system or user problems and appear in boxes with this format separated from the running text.

WARNING

Warnings indicate information that may prevent personal injury or equipment damage and appear in boxes with this format separated from the running text.

1.1 What is the SBC-GPC3?	1-3
1.1.1 Features of the SBC-GPC3	1-3
1.1.2 Inputs, Outputs vs. Points	1-3
1.2 Inputs	1-4
1.2.1 Universal Inputs	1-4
1.2.2 Digital Inputs	1-4
1.3 Outputs	1-5
1.3.1 Analog Outputs	1-5
1.3.2 Digital Outputs	1-5
1.4 STATbus	1-6
1.4.1 Inputs on the STATbus	1-6
1.4.2 Outputs on the STATbus	1-6
1.5 Specifications	1-7
1.5.1 Networking	1-7
1.5.2 Terminations	1-7
1.5.3 Power Requirements	1-7
1.5.4 Outputs	1-7
1.5.5 Operating Environment	1-7
1.5.6 Battery Backup	1-7
1.5.7 Dimensions	1-7
1.5.8 Agency Approvals	1-7
2.1 Introduction	2-3
2.2 Installation	2-4
2.2.1 Mounting the SBC-GPC3	2-4
2.2.2 Powering the SBC-GPC3	2-5
2.2.3 Connecting the RS-485 Network	2-9
2.3 Universal Inputs	2-13
2.3.1 Configuring Current Inputs	2-13
2.3.2 Configuring Voltage Inputs	2-13
2.3.3 Configuring Thermistor Inputs	2-14
2.3.4 Configuring Non-Linear Inputs	2-14
2.3.5 Digital Inputs	2-15
2.4 Digital Inputs	2-16
2.4.1 Configuring Digital Inputs	2-16
2.5 Analog Outputs	2-17
2.5.1 Configuring Analog Outputs	2-17
2.6 Digital Outputs	2-21
2.6.1 Configuring Digital Outputs	2-21
2.7 Remote I/O	2-22
2.7.1 Connecting Devices to the STATbus	2-22
2.7.2 Length of the network	2-23
2.7.3 Number of Devices	2-24
2.7.4 Powering STATBus Devices	2-26
2.7.5 Distribution of devices	2-27
2.7.6 Mapping Remote I/O Devices to Channels	2-27

3.1 System, FF00.....	3-3
3.1.1 About.....	3-3
3.1.2 Power-Up	3-4
3.1.3 Network Configuration.....	3-4
3.1.4 Setup.....	3-4
3.2 STATbus 1-4, FF01-FF04.....	3-11
3.3 Universal Input Summary, FE00	3-13
3.4 Universal Inputs 1-24, FE01-FE18.....	3-16
3.5 Digital Input Summary, FE30.....	3-25
3.6 Digital Input, FE31-FE38.....	3-27
3.7 Occupancy Detector, FC01.....	3-31
3.8 Analog Output Summary, FD00.....	3-33
3.9 Analog Outputs 1-12, FD01-FD0C.....	3-35
3.10 Digital Output Summary, FB00	3-38
3.11 Digital Outputs 1-12, FB01-FB0C	3-42
3.12 PID Control 1-12, FA01-FA0C	3-46
3.13 Thermostatic Control 1-12, FA11-FA1C	3-59
3.14 Floating Point Control 1-2, FA21-FA22.....	3-63
3.14.1 PI Control	3-65
3.14.2 Reset Feature	3-70
3.14.3 Schedule Control.....	3-71
3.14.4 Interlock, Communications and Fire Failure Positioning	3-73
3.14.5 Calibration	3-74
3.15 Schedule Summary, F900	3-78
3.15.1 Zone Scheduling	3-78
3.16 Schedules 1-8, F901-F908	3-82
3.17 Scales 1-4, F711-F714	3-86
3.18 Piecewise Curves 1-2, F701-F702.....	3-88
3.19 Math 1-2, F311-F312	3-92
3.20 Averages 1-3, F301-F303	3-95
3.21 Logic 1-4, F321-F324.....	3-97
3.22 Program Summary, F200.....	3-100
3.23 Programs 1-8, F201-F208.....	3-103
3.24 Input Select 1-4, F011-F014	3-106
3.25 Broadcast 0-7, F000-F007	3-108
4.1 Introduction	4-3
4.2 Temperature Display.....	4-4
4.3 Setpoint Adjustment Display	4-5
4.3.1 SBC-STAT2D.....	4-5
4.3.2 SBC-STAT3	4-5
4.4 Override Mode	4-8
4.5 SBC-STAT3 Menus	4-9
4.6 User Menu	4-10
4.7 Service Menu	4-11
4.7.1 Control Monitor.....	4-11

4.7.2 Temp Offset	4-13
4.7.3 Version.....	4-13
4.7.4 Reset.....	4-14
4.8 Install Menu	4-15
4.8.1 Control Monitor	4-15
4.8.2 LED Test.....	4-15
4.8.3 Properties.....	4-16
4.8.4 Reset.....	4-17
5.1 SPL: An Overview.....	5-3
5.1.1 What is SPL?	5-3
5.1.2 SPL and the SBC-GPC3.....	5-3
5.1.3 Creating an SPL Program for an SBC-GPC3	5-3
5.2 SPL Features Summary	5-5
System Channel, FF00	A-3
StatBus Channels 1-4, FF01-FF04.....	A-7
Universal Input Summary, FE00.....	A-8
Universal Inputs 1-24, FE01-FE18	A-11
Digital Input Summary, FE30.....	A-14
Digital Inputs 1-8, FE31-FE38	A-16
Occupancy Detector, FC01	A-19
Analog Output Summary, FD00.....	A-20
Analog Outputs 1-12, FD01-FD0C	A-21
Digital Output Summary, FB00.....	A-23
Digital Outputs 1-12, FB01-FB0C.....	A-26
PID Control 1-12, FA01-FA0C.....	A-28
Thermostatic Control 1-12, FA11-FA1C	A-31
Floating Point Control 1-2, FA21-FA22.....	A-33
Schedule Summary, F900	A-36
Schedules 1-8, F901-F908	A-39
Scales 1-4, F711-F714	A-40
Piecewise Curves 1-2, F701-F702	A-41
Math 1-2, F311-F312.....	A-43
Averages 1-3, F301-F303.....	A-44
Logic 1-4, F321-F324	A-45
Program Summary, F200	A-47
Programs 1-8, F201-F208	A-49
Input Select 1-4, F011-F014	A-51
Broadcast 0, F000	A-52
Broadcast 1, F001	A-53
Broadcast 2, F002	A-54
Broadcast 3, F003	A-55
Broadcast 4, F004	A-56
Broadcast 5, F005	A-57
Broadcast 6, F006	A-58
Broadcast 7, F007	A-59

SECTION 1: OVERVIEW

This section describes the SBC-GPC3, outlines key components and features, and provides operating specifications for the controller.

IN THIS SECTION

What is the SBC-GPC3?.....	1-3
Features of the SBC-GPC3	1-3
Inputs, Outputs vs. Points	1-3
Inputs	1-4
Universal Inputs	1-4
Digital Inputs	1-4
Outputs.....	1-5
Analog Outputs	1-5
Digital Outputs.....	1-5
STATbus.....	1-6
Inputs on the STATbus.....	1-6
Outputs on the STATbus.....	1-6
Specifications	1-7

1.1 WHAT IS THE SBC-GPC3?

As the ultimate PUP controller, the SBC-GPC3 offers complete stand-alone control as well as full peer-to-peer capabilities with other devices on the same physical PUP network. The flexibility of inputs, outputs and programmable capabilities allows the SBC-GPC3 to be used in a wide variety of applications, including large built up air handling units, central plant control, multiple boilers, optimization, pump control, and load shed algorithms to name a few.

1.1.1 FEATURES OF THE SBC-GPC3

- ▼ Standalone or networked operation
- ▼ Twenty-four (24) universal inputs
- ▼ Eight (8) digital inputs
- ▼ Twelve (12) analog outputs
- ▼ Twelve (12) digital output points
- ▼ Four (4) STATbus channels
- ▼ Easy configuration and firmware updates via software tools such as SoloPro
- ▼ RS-485 communications rate up to 115.2k
- ▼ Battery-backed real time clock and memory
- ▼ Self-diagnostic circuits and LED indicators for power, I/O, network activity, processor and programs.

1.1.2 INPUTS, OUTPUTS VS. POINTS

The SBC-GPC3 has a number of features that make it different from previous American Auto-Matrix controllers, the most notable of which is its ability to use remote I/O devices connected via STATbus. Remote I/O behaves in the same way as on-board I/O, except that it is located remotely from the controller. Because they are not on-board, each remote device requires a unique address, known as a Global Identification (GID) number so that the controller may recognize and direct communications to it. The SBC-GPC3 internally maps these GID numbers to its inputs and outputs.

This means that a distinction must be made between the internal representation of an input or output and the physical connection where the device is connected to the controller, be it on-board or remote. When a reference is made to an input or output, it is assumed to be the internal representation of that input or output in the controller. When a reference is made to the physical connection for a given input or output, the term "point" will be added. For example, "Digital Input Point" would refer to the connection where the digital input was connected. In this way, "Universal Input 14" would refer to the fourteenth universal input channel in the controller while "Universal Input Point 7" would be the seventh physical connection for a universal input. The SBC-GPC3 internally associates physical connections, such as "Universal Input Point 7", with internal representation, such as "Universal Input 7".

1.2 INPUTS

The SBC-GPC3 has no on-board I/O. All inputs and outputs to the SBC-GPC3 will be connected via the four (4) STATbus channels. Each STATbus channel is capable of handling a maximum of thirteen (13) devices each. The SBC-GPC3 has twenty-four (24) universal inputs and can map input points on the STATbus to these addresses. This mapping assigns an input to an address.

1.2.1 UNIVERSAL INPUTS

Within the SBC-GPC3, there are twenty-four (24) universal inputs. The controller has the ability to map input points on the STATbus onto these twenty-four universal inputs. Using NB-Pro, the controller can be configured to associate the input signal from a given hardware point to a universal input.

Each universal input may be configured to behave as a digital (on/off) input, 0-5 volt, 0-10 volt, or 0-20mA scaled linear input, thermistor, or piecewise linear approximation. All ranges may be inverted for reverse-reading sensors. Thermistor input points may be configured to read either Fahrenheit or Celsius degrees over a temperature ranges from -30.0 to 230.0°F (-34.0 to 110.0°C). Piecewise linear approximation uses a programmable table for scaling. Two separate tables are available, each being defined by ten linear segments which approximate a characteristic curve. Input polarity is selectable for points configured as digital inputs. Each point configured as an analog input has programmable high and low alarm limits. If point is used as a digital input, alarms can be generated for off-to-on transitions, on-to-off transitions or both

1.2.2 DIGITAL INPUTS

The SBC-GPC3 has eight (8) digital inputs which are updated every 100 ms and are capable of measuring a signal with a pulse width as short as 50ms in pulse counter mode. The digital inputs have configuration settings similar to those of a universal input configured to read a digital signal. The digital inputs, however, operate at a much higher frequency allowing them to be used for such application as flow totalization and flow metering.

1.3 OUTPUTS

1.3.1 ANALOG OUTPUTS

The SBC-GPC3 has a total of twelve (12) analog outputs that allow analog output points to be mapped from the STATbus.

The outputs can be configured to output either a 0-10V or 0-20mA signal with 16 bits of resolution. In addition, each output can be configured as either normal or reverse acting. The outputs can be controlled automatically, manually or through an SPL program. All outputs allow for interlocking and interlock failure alarming.

1.3.2 DIGITAL OUTPUTS

The SBC-GPC3 has a total of twelve (12) digital outputs that allow digital output points to be mapped from the STATbus.

The outputs provide on/off control for devices such as fans, valves or heating stages via 12-29 VAC, 1A triacs. All digital outputs can be configured to enforce a minimum cycle time and each output allows for runtime alarming.

1.4 STATBUS

STATbus is an open-topology network that allows flexible connection of up to thirteen STATbus devices per channel using a non-polar, twisted pair cable. This provides unprecedented flexibility in the installation and wiring of I/O devices to the SBC-GPC3. Substantial saving can be realized in both wiring and installation costs as compared to conventional sensors. STATbus uses digital communications signals, giving it a higher level of noise immunity than conventional, analog sensors.

NOTE

The SBC-GPC3 may only use digital STATs (STAT1D, STAT2D, STAT3) on it's STATbus. Analog STATs may not be used with the SBC-GPC3.

1.4.1 INPUTS ON THE STATBUS

The SBC-GPC3 has twenty four Universal Inputs and four Pulse Inputs available for mapping STATbus devices. By connecting different IOX modules, the SBC-GPC3 can be configured to have a nearly limitless combination of inputs up to the limits stated above.

1.4.2 OUTPUTS ON THE STATBUS

Up to twelve analog and twelve digital outputs may be connected to the SBC-GPC3 via STATbus channels. These devices will behave, in all respects, like a normal analog output. The only difference will be to which network the device is physically connected.

1.5 SPECIFICATIONS

1.5.1 NETWORKING

- ▼ **line signaling:** RS-485
- ▼ **wiring:** shielded, twisted pair
- ▼ **network protection:** dual tranzorbs, PTC
- ▼ **communications speed:** up to 115.2k baud, selectable termination resistor
- ▼ **network configuration:** multidrop bus, per RS-485 specification and practice
- ▼ **communications protocol:** PUP

1.5.2 TERMINATIONS

- ▼ Pluggable terminal blocks for inputs, outputs, power, network, and STATbus connections.

1.5.3 POWER REQUIREMENTS

- ▼ NEC Class 2 transformer
- ▼ 22-29 VAC, 50/60 Hz, 3.65 A max
- ▼ PTC protection

1.5.4 OUTPUTS

- ▼ Analog Outputs: 0-10 VDC into 1 k Ω load or 0-20 mA into 250 Ω load.
- ▼ Digital Outputs: will switch 10-29 V_{rms} 50/60 Hz at 1 A resistive or inductive load.
- ▼ Digital outputs provide varistor protection.
- ▼ 24 VAC Out: rated 24 V, 1.3 A max 50/60 Hz

1.5.5 OPERATING ENVIRONMENT

- ▼ **temperature range:** 32-122°F (0-50°C)
- ▼ **humidity range:** 0-80% RH, non-condensing
- ▼ **altitude:** up to 2000m

1.5.6 BATTERY BACKUP

- ▼ Only Sanyo CR-1/3N or Duracell CL-1/3N battery rated 3.0 VDC is to be used. (Not user replaceable).

1.5.7 DIMENSIONS

- ▼ **size:** 8.407 x 6.5 x 1.25 in. (20.83x16.51x3.18 cm)
- ▼ **shipping weight:** 3 lb. (1.36 kg)

1.5.8 AGENCY APPROVALS

- ▼ UL Listed Management Equipment, Energy (PAZX) UL standard 916
- ▼ UL Recognized Temperature-Indicating and Regulating Equipment – Component (XAPX2) UL standard 873
- ▼ Complies with FCC Part 15, subpart B, for Class B Computing Device
- ▼ Complies with CE Directive and Standards

SECTION 2: WIRING, INSTALLATION & USAGE

This section describes how to make the necessary connections for power and network communications to the SBC-GPC3. Connection of input and output devices, as well as the use of remote I/O on the STATbus is covered as well.

IN THIS SECTION

Introduction	2-3
Installation	2-4
Mounting the SBC-GPC3	2-4
Powering the SBC-GPC3.....	2-5
Connecting the RS-485 Network.....	2-9
Universal Inputs	2-13
Configuring Current Inputs	2-13
Configuring Voltage Inputs	2-13
Configuring Thermistor Inputs.....	2-14
Configuring Non-Linear Inputs	2-14
Digital Inputs	2-15
Digital Inputs	2-16
Configuring Digital Inputs	2-16
Analog Outputs	2-17
Configuring Analog Outputs	2-17
Configuring Analog Outputs	2-17
Digital Outputs.....	2-21
Configuring Digital Outputs	2-21
Remote I/O	2-22
Connecting Devices to the STATbus.....	2-22
Mapping Remote I/O Devices to Channels	2-27

2.1 INTRODUCTION

This section will explain the steps necessary to successfully mount the SBC-GPC3, supply power to the controller, connect the controller to the communications network and connect and configure the controller's inputs and outputs.

2.2 INSTALLATION

IMPORTANT

If the equipment is used in a manner not specified by AAM, the protection provided by the equipment may be impaired.

There are three main steps to installing the SBC-GPC3. First the controller must be physically mounted. Second, the controller must be connected to a suitable power supply. Third, the controller must be connected to the RS-485 communications network.

NOTE

All equipment must be installed by a licensed electrician in accordance with the NEC/CEC and local codes.

2.2.1 MOUNTING THE SBC-GPC3

The SBC-GPC3 should be mounted to a site which provides access to a stable 24 VAC power transformer from which the controller will draw its power. The temperature of the mounting location must be between 32° F and 122° F (0° C to 50° C) with a relative humidity of 0-80% non-condensing.

The mounting area should be flat and unobstructed by other equipment or machinery, free of moisture, and located away from potential leakage.

IMPORTANT

The case of the SBC-GPC3 must be connected to a reliable earth ground.

The mounting dimensions for the SBC-GPC3 are shown in Figure 2-1.

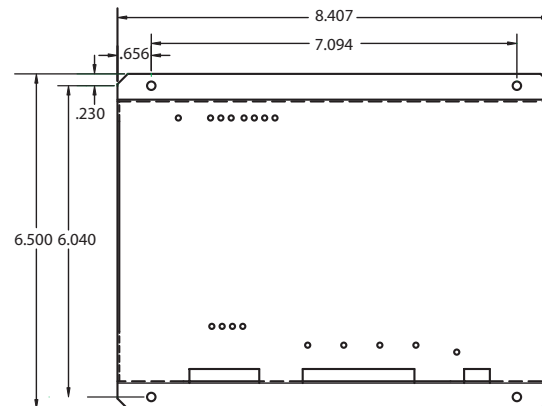

Figure 2-1: Mounting Dimensions for the SBC-GPC3 (all dimensions in inches)

NOTE

When installing the SBC-GPC3 make sure that there is sufficient room to allow insertion and removal of the terminal block plugs.

2.2.2 POWERING THE SBC-GPC3

The SBC-GPC3 can be used in a variety of configurations. Because of this, the power requirements of the controller can vary greatly and are very much application specific. The SBC-GPC3 requires power for both the on-board I/O and the power outputs on the STATbus ports.

WARNING

The SBC-GPC3 must be used with an approved external disconnect device rated for at least 24 VAC, 0.65 A. The disconnect device must be located near the equipment.

NOTE

All American Auto-Matrix products are listed as UL Class 2 devices. To maintain conformance with that listing, all transformers connected to them must be UL listed, Class 2 devices.

The SBC-GPC3 requires a 22-29 VAC, 50/60 Hz NEC Class 2 transformer capable of providing a minimum of .65 A. The transformer is connected to the SBC-GPC3 at pins 43 and 44 on terminal block TB12 as shown in Figure 2-2.

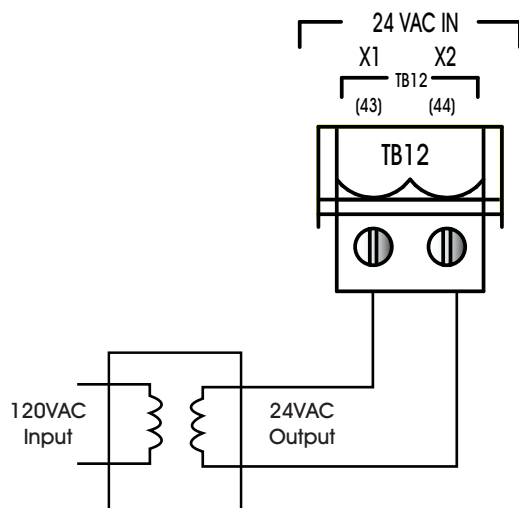

Figure 2-2: Connecting Power to the SBC-GPC1

A .65 A power supply will provide only enough current to power the SBC-GPC3's processor and other circuitry as well as STATbus device that do not require power. Using a transformer of this size, you should not use the power outputs on the STATbus connectors.

If your application includes STATbus device which require power, then you will require a power supply capable of delivering more than the .65 A minimum. The SBC-GPC3 is can be used with an NEC Class 2 power supply up to a maximum of 3.65 A.

The controller has built in protection circuits which will allow you to draw up to 3.0 A total from all of the STATbus ports. This may be used to power IOX modules and the devices connected to them.

If you choose to use powered STATbus devices and do not want to simply use the largest rated transformer, you must determine how large a transformer is required for your application and if you will need to supplement that power with an external transformer. To determine this rating, you need to

determine the total current draw for all the powered STATbus devices and any devices, such as actuators, relays, sensors, etc., that you plan to connect to those STATbus devices. The total current is given by:

$$\text{STATbus device current} = \text{Current to power device} + \text{Current draw of actuator(s)/relay(s)/sensor/etc.}$$

The current required to power the various STATbus devices is given in Table 2-1. The current draw for the input or output device(s) you connect to the STATbus devices should be found in the manufacturer's data provided with the device.

Table 2-1 Current to Power Various STATbus Modules

Module	Nominal Current Draw
SSB-U11	75 mA
SSB-AO1	75 mA
SSB-D11	75 mA
SSB-IOX1	125 mA
SSB-DO1, SSB-DO1-I, SSB-DO2, SSB-DO2-I	(See NOTE below)

NOTE

The power connection on the SSB-DO1, SSB-DO1-I, SSB-DO2, and SSB-DO2-I modules is only used to energize the relay coil(s) on those modules. They draw their operating power from the SSB pins and, for the purpose of calculating the total current draw, you only need to consider the power required to actuate the relay coils. Each relay coil requires 50 mA so an SSB-DO1 and SSB-DO1-I would add 50 mA per device to the total current requirement whereas the SSB-DO2 and SSB-DO2-I would add 100 mA per device.

If the total current draw for all devices connected via the STATbus is less than or equal to 3.0 A, then the maximum current rating required for the transformer is found by adding the total power requirements for devices using the 24 VAC output and the power required by devices on the STATbus to the .65 A required to run the GPC itself, up to the 3.65 A maximum. In other words:

$$\text{Required Supply Current (Amps)} = .65 + \text{STATbus device current}$$

If, however, the total for all devices connected via the STATbus is greater than 3.0 A, then your application will require a separate, external transformer to provide the additional power needed.

If you are using an external transformer to power STATbus devices, you can still simplify your wiring by mounting the additional transformer near the GPC and using a single 18 ga., 4-conductor, twisted pair cable to carry both communications and power just as you would if you were using the power outputs from the STATbus. The wiring diagram in Figure 2-3 shows how you can connect an external transformer to the power wires that would otherwise be connected to the power outputs pins on the STATbus port.

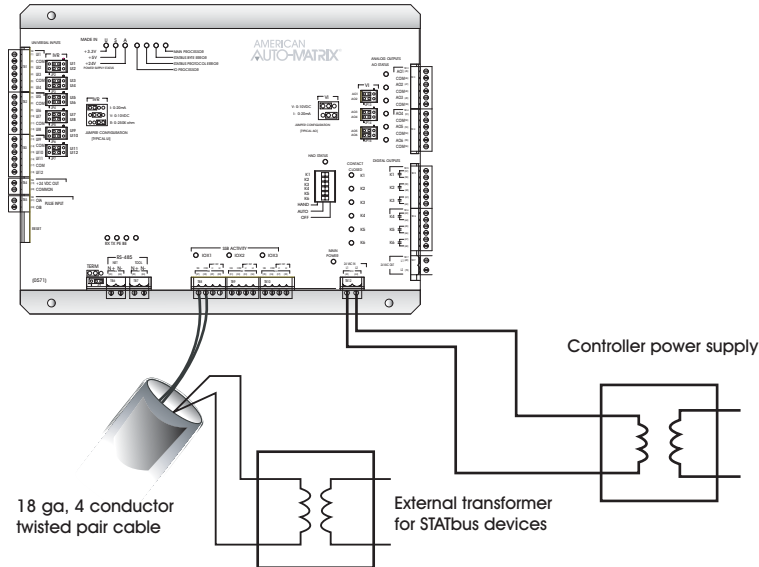

Figure 2-3: Using an External Transformer with 4-wire STATbus Cabling

WARNING

You should **never** connect an external transformer to a STATbus cable that is also connected to the power outputs on the SBC-GPC3.

Once power is connected to the SBC-GPC3, the Main Power light, located to the left of TB12 as shown in Figure 2-4, should be lit.

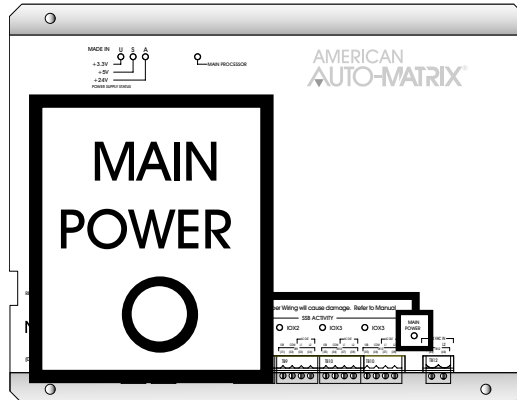

Figure 2-4: Location of the Main Power indicator

The Power Supply Status lights, shown in Figure 2-5, indicate that the 3.3 V, 5 V, and 24 V on-board power supplies are functioning properly. The Main Processor light will begin to blink. When the processor is functioning normally, this light will cycle on and off approximately every second.

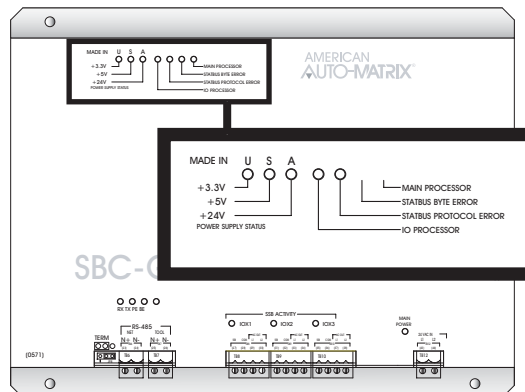

Figure 2-5: Location of the Power Supply Status Indicators and the Main Processor Indicator

2.2.3 CONNECTING THE RS-485 NETWORK

The SBC-GPC3 communicates over an RS-485 network. As shown in Figure 2-6, the SBC-GPC3 has two network connections at terminal blocks TB6 and TB7. The RS-485 network is connected to terminal block TB6 using 14-22 AWG, shielded, twisted pair wiring making sure to maintain polarity between devices.

The shield wire run to the first controller in the network should be connected to a reliable earth ground. At each connection along the network, i.e. from the first to the second, the second to the third, etc., the shield wires should be connected together and taped back. At the last controller, the shield wire should simply be taped back.

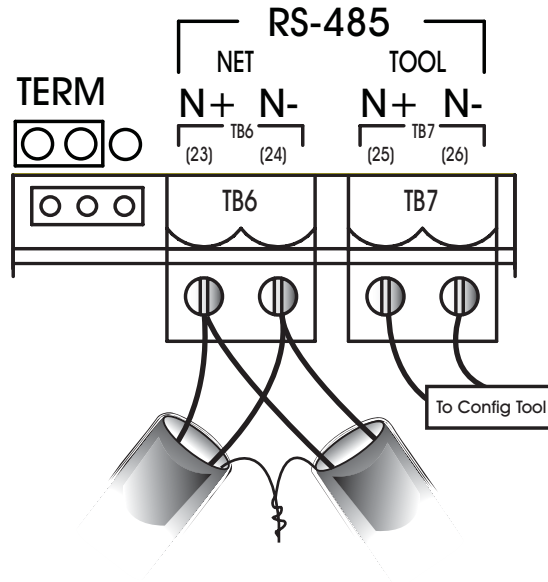

Figure 2-6: Proper Connection of the SBC-GPC3 to an RS-485 Network

IMPORTANT

All RS-485 communications networks should be installed using shielded, twisted pair wiring. Each twisted pair must be individually shielded. Unshielded cables must be placed in metal conduit alone. Communications wiring should not be routed together with, or close to, wiring carrying DC switching, AC lines, fluorescent lighting or any other RFI/EMI emitting source. Failure to meet these requirements may result in various communications problems, such as excessive network retries, noise susceptibility, and/or a complete loss of communications.

The second network port on the SBC-GPC3, terminal block TB7, is intended for the temporary connection of a configuration device. This device can be used to change the values of attributes within the SBC-GPC3, enabling the user to configure the SBC-GPC3 without having it be connected to a host computer. The connection at TB7 is NOT intended for connection of devices that are part of the building RS-485

network. That way, if the SBC-GPC3 were to be removed for some reason, the RS-485 network would be left intact.

IMPORTANT

The second network connection, located at terminal block TB7, is not to be used for communications between PUP devices. It is intended for the temporary connection of a configuration tool to the SBC-GPC3. PUP devices on the network should not be connected to terminal block TB7.

For SBC-GPC3 units that are electrically last on the network, it may be necessary to connect a termination resistor across the N+ and N- terminals to minimize unwanted communications line effects, such as signal reflection. Only the end units on the multi-drop network should be terminated. The SBC-GPC3 provides the option of connecting an internal, jumper-selectable, 249 Ω termination resistor across the N+ and N- terminals. To connect the termination resistor, the TERM jumper, located to the left of TB6, should be moved to the left two pins as shown in Figure 2-7a. To disconnect the internal termination resistor, move the TERM jumper to the right two pins as shown in Figure 2-7b. If necessary, additional and termination resistance can be added by connecting a resistor between the N+ and N- pins.

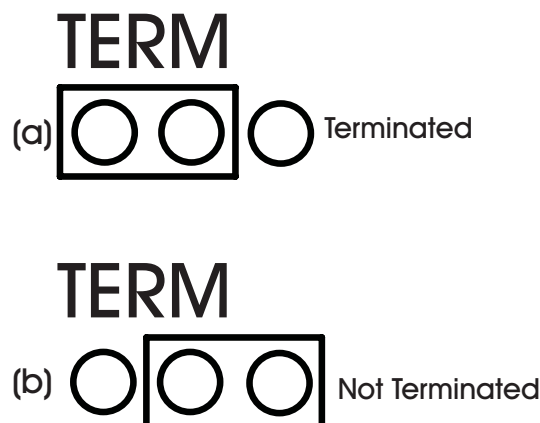

Figure 2-7: Configuring the TERM Jumper for RS-485 Communications Termination

If, at this point, you communicate with the controller, the RX and TX lights, located just above terminal blocks TB6 and TB7, shown in Figure 2-8, should blink rapidly, indicating that the controller is communicating over the network.

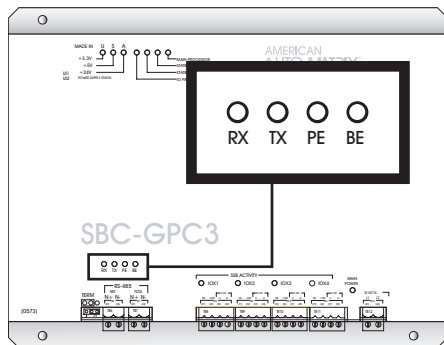

Figure 2-8: Network Status Indicator Lights

The BE light indicates that a Byte Error has occurred. This type of error occurs when information is being transferred over the network and data is lost. A Byte Error occurs if a problem is detected in the start, stop, or data bit timings. This type of error would also be generated if communication baud rates do not match. In this case, the SBC-GPC3 detects that the error has occurred, lights the BE light and sends a request over the network for the information to be resent.

A packet of data is a number of bytes of data that are transmitted over the network together. Each packet of data includes a checksum value used to validate the data. A Packet Error occurs when SBC-GPC3 detects a mismatch between the calculated checksum and the value received with the packet. The most common reason for a packet error is if more than one unit is trying to talk on the network at once, indicating the presence of more than one token or some other configuration error. Packet errors can also be caused by faulty transmission or reception of a data packet. When this happens, the PE light will be lit, indicating that such an error has occurred. A request will then be sent for the data to be retransmitted.

2.3 UNIVERSAL INPUTS

The SBC-GPC3 provides a total of twenty four universal inputs (UIs). All of these inputs are exclusively for use with STATbus devices and can be configured to make use of remote inputs on SSB-FI1, SSB-UI1, SSB-DI1 and SSB-IOX1 modules.

Each universal input may be configured to read either a digital or analog signal. Each input may be configured individually to read any of the following:

- ▼ digital (on/off)
- ▼ linear inputs (0-5 V, 0-10 V, 0-20 mA, 4-20 mA, etc.) scaled between a programmable minimum and maximum value
- ▼ non-linear inputs with response provided via two programmable piecewise curves
- ▼ thermistor (Precon type III 77° @ 10kΩ)
- ▼ SMARTStat device

2.3.1 CONFIGURING CURRENT INPUTS

Any sensor which generates a signal in the form of a current is classified as a current sensor. Ranges of 0-20 mA and 4-20 mA are common in sensors. The current produced by these sensors is directly proportional to the value being measured. For example, if a pressure sensor measured 0 to 5 inches of water gauge and had an output range of 0 to 20 mA, then a reading of 10 mA would correspond to a pressure of 2.5 inches of water gauge.

To specify the sensor type, you must open the Universal Input channel corresponding to the input you are configuring. Next, you want to set the **ST** attribute to “MN..MX 4 to 20 mA”, for 4-20 mA inputs, or “MN..MX 0 to 20 mA”, for 0-20 mA inputs. That tells the SBC-GPC3 that a current sensor is connected and specifies its range.

You also need to specify the range over which the sensor operates. This is necessary so that the SBC-GPC3 can calculate the measured value from the input signal. The **MN** attribute should be set to the lowest value that your sensor can measure. The **MX** attribute should be set to the maximum scaled value for your input.

As an example, sensors which measure relative humidity are often current sensors that operate in the 4-20 mA range. For a sensor of this type you would set **ST**="MN..MX 4 to 20 mA" because the sensor measures 4-20 mA. Relative humidity ranges from 0 to 100% so you would set **MN**=0 and **MX**=100 to represent the limits of the sensor's output. In this case, a raw value of 4 mA would be scaled to a value of 0% in engineering units. The relative humidity sensor would read 100% if the input were reading a signal of 20mA.

2.3.2 CONFIGURING VOLTAGE INPUTS

Any sensor which puts out a voltage in response to a measured value is classified as a voltage sensor. Voltage sensors behave in very much the same way as current sensors. The primary differences have to do with the internal circuitry of the SBC-GPC3 and how the signal is read.

To specify the sensor type, you must to go to Universal Input channel corresponding to the input you are configuring. Next, you want to set the **ST** attribute to “MN..MX 0 to 5 V”, for 0-5 V inputs, or “MN..MX 0 to 10 V”, for 0-10 V inputs.

You also need to specify the range over which the sensor operates. This is necessary so that the SBC-GPC3 can calculate the measured value from the input signal. The **MN** attribute should be set to the lowest value that your sensor can measure. This would correspond to the reading at zero volts. The **MX** attribute should be set to the maximum scaled value for your input. For example, if a 0-10 V carbon

dioxide sensor measuring from 0-5000 ppm would have **MN** would be set to 0 and **MX** would be set to 5000.

2.3.3 CONFIGURING THERMISTOR INPUTS

The thermistor is one of the most common types of resistive sensors for temperature measurement. The thermistor's combination of high accuracy over a wide range coupled with its low cost makes it one of the most popular temperature sensors used. Because of the thermistor's popularity, the SBC-GPC3 has the response curve for a **precon type III** thermistor built in.

For a thermistor input, you want to set the **ST** attribute equal to "TH -30.0 to 230.0", which corresponds to a thermistor. The SBC-GPC3 will then automatically set the **MN** to -30.0 and the **MX** to 230.0, the minimum and maximum values that can be read by this type of sensor. The temperature will now be displayed in the **CV** attribute of this channel. The value of **CV** will also be displayed in the Universal Input Summary channel.

At this point, it is helpful to give the channel a name so it can be easily identify in the future. You can name the channel by setting the value of the **ON** attribute. You should then check the reading and adjust any disagreement between the sensor and a known reading using the **OF** attribute. This specifies a fixed offset for the sensor and would be used if the sensor reading was off by a fixed amount. For example, if a sensor was reading three degrees below the actual room temperature. In that case, you would set **OF**=3.0 to correct the reading.

If you are not going to configure any alarming function for this input, then you have set all the parameters which need to be set for the thermistor to provide a reading.

2.3.4 CONFIGURING NON-LINEAR INPUTS

The thermistors discussed previously are just one example of a sensor who's output characteristics are well defined. Because precon type III thermistors are so prevalent, the output response curve is included with the controller. However, there are a number of other common resistive sensors who's response is non-linear. For these types of inputs, the SBC-GPC3 provides the option of using one of the two Piecewise Curve channels to specify the response of the input device.

To use an input with a non-linear response, you must define the piecewise curve and then set the input to use the curve you have defined to scale its readings. The process for defining the Piecewise Curve is given in Section 3.18, "Piecewise Curves 1-2, F701-F702". The response data necessary to construct the curve will usually be available in the catalog from which the sensor was ordered or on the data sheet accompanying the sensor.

You then set the **ST** attribute to "Curve 1" or "Curve 2". This tells the SBC-GPC3 to use Piecewise Curve 1 or 2 with this channel. The next step is to set the minimum and maximum scaled values using the **MN** and **MX** attributes. The **MN**, should be set to the lowest scaled value from your piecewise curve. For most applications this will correspond to the value of **Y1** in the Piecewise Curve channel. Similarly, **MX** should be set to the maximum scaled value for the input. This will most likely be the value of **YB** in the Piecewise Curve channel.

At this point, you should give the channel a name so that you can easily identify it in the future. You can name the channel by setting the value of **ON**.

2.3.5 DIGITAL INPUTS

An input that only has two signal states is considered a digital input. The most basic digital inputs are switches or contacts. The switch is either on or off, the contact is closed or open. Inputs of this type have many uses in a building automation system.

For a digital sensor, you will set the **ST** attribute to "Digital".

Digital inputs can take one of two states, but you can tell the controller how you want it to treat those states. By setting the **IP** attribute you can specify whether the SBC-GPC3 treats a low voltage as **CV=0** (normal operation, **IP**="Low Voltage is CV=0") or a high voltage as **CV=0** (reverse operation, **IP**="High Voltage is CV=0").

Digital inputs have an input filter delay, **IF**, which specifies the time, in seconds, which the input's state must remain steady for the reading to be seen as reliable. This means that a signal that does not remain steady for **IF** seconds will be seen as a spurious signal and will cause the input reliability, **RE**, to be set to "unreliable". This means that the signal is changing too rapidly to be considered reliable and should not be used for control functions.

2.4 DIGITAL INPUTS

The SBC-GPC3 has eight digital input channels with dedicated pulse counting features. These digital inputs are capable of detecting signals in the range 3-40 VDC peak to peak or 2-29 VAC at 50/60 Hz. They can be configured to detect either DC pulses, up to 20 per second, or the presence of an AC signal at a higher frequency. Digital Inputs 1-8 allow pulse counting, digital input points to be added via STATbus devices.

The digital inputs operate at a much higher frequency than a Universal Input. This makes it possible for the input to not only detect whether a signal is on or off, but to detect rapid pulses from the input. These pulses would be used primarily for demand metering applications as part of an energy management system. Digital, pulse counting inputs can also be used in flow metering applications.

Regardless of the specific application, all pulse counting, digital inputs operate on the same principle. The device will generate a pulse for a given quantity of the value that is being measured for a demand metering application. One pulse might correspond to one kilowatt-hour of power whereas, for a flow metering setup, a single pulse might correspond to one gallon of liquid. The important piece of information is the correlation between pulses and measured values.

2.4.1 CONFIGURING DIGITAL INPUTS

To configure a digital pulse counting input, you must set the FE3x;MD attribute (where x is the number of the Digital Input channel being used) to "Rising Edge", "Falling Edge", or "Both". This tells the SBC-GPC3 that you want the input to operate as pulse counter and not a simple digital input.

NOTE

MD must be set to "3=Disabled" for the input to track the run hours and generate run limit alarms.

To correlate pulses with the value being measured, you must enter a value for the **SF** attribute. This multiplier specifies the amount of the measured quantity that is accumulated for each pulse. For example, if a demand meter sends out a pulse for each kilowatt-hour of power used, then you would set **SF**=1.0 since one pulse corresponds to one kilowatt-hour. If your input device were a flow meter that sent a pulse for every ten gallons of liquid that passed through a pipe, then you would set **SF**=10.0.

The total number of pulses accumulated will be displayed in the **NP** attribute. While this can be useful, you will be more concerned with the scaled pulse count stored in the **SV** attribute. This is the value of the total number of pulses, **NP**, multiplied by the scaling factor, **SF**. **SV** gives you the total amount of the value that you are measuring. For example, if the SBC-GPC3 has accumulated 1250 (**NP**=1250) pulses and each pulse corresponds to 2.5 gallons of liquid that has been pumped through a pipe (**SF**=2.5), then the total amount of liquid pumped (**NP**×**SF**) would be displayed in **SV**. In this case, **SV** would have a value of 3125, meaning that 3125 gallons of liquid had been measured.

2.5 ANALOG OUTPUTS

2.5.1 CONFIGURING ANALOG OUTPUTS

Both voltage and current outputs can be configured to work as either normal- or reverse-acting. The analog outputs on the SBC-GPC3 can operate in automatic mode, where the output is controlled by the SBC-GPC3's control loops, or manual mode, where the value of the output is set by the user or by an SPL program. The minimum and maximum desired positions can be specified and the output can be interlocked using one or more inputs.

Attributes **LS** and **HS** are used to specify the low and high scaled output attributes. These attributes specify a range of the total output signal, specified as a percentage, that is then scaled across **MN** and **MX**. For example, if the **CV** is to be displayed as a percentage (0-100%) of a 10 VDC output range, set **MN** to 0 and **MX** to 100 (a display range of 0%-100%). Then set **LS**=0.0 and **HS**=100.0 (the full range of the output signal), because **CV**=0 represents 0.0% of the output range and **CV**=100 represents 100.0% of the output range. This is shown in Figure 2-9.

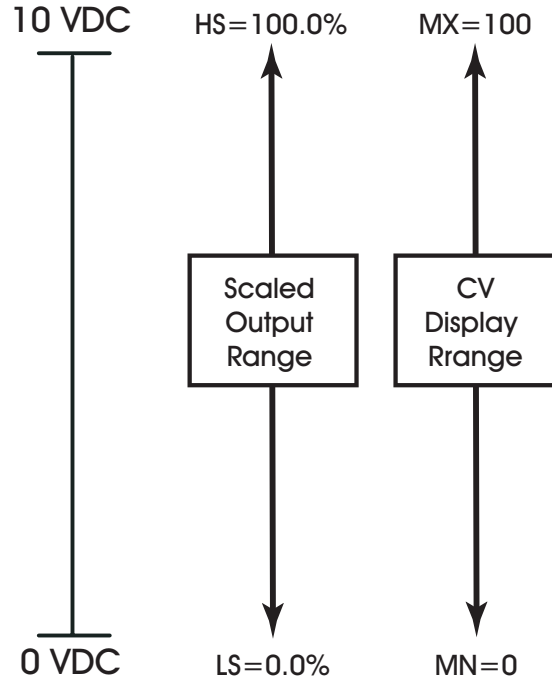

Figure 2-9: 0 to 10 V Displayed as a Percentage

If the output device in the previous example only operated from 2-10 V instead of 0-10 V, you would simply change the value of **LS** to be 20.0 (2 V = 20% of 10 V) and everything else would remain the same. This can be seen in Figure 2-10.

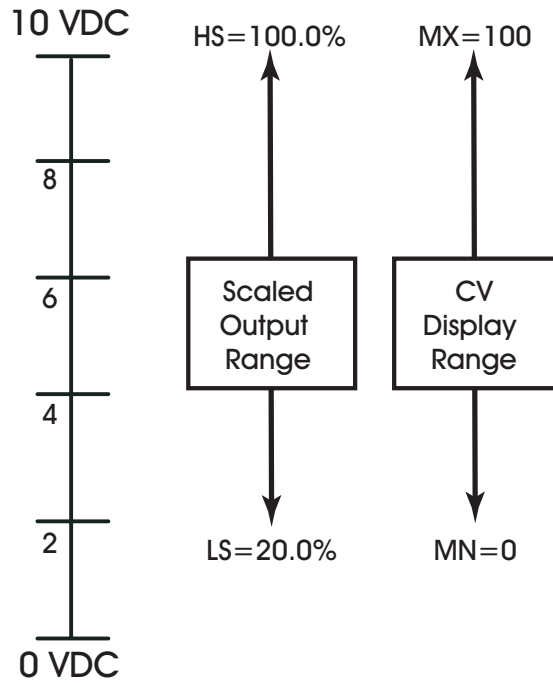

Figure 2-10: 2 to 10 V Displayed as a Percentage

This 2-10 V Output could also be configured to display the actual output voltage by setting **MN**=2 and **MX**=10. This would display **CV** in the range of 2-10 as shown in Figure 2-11.

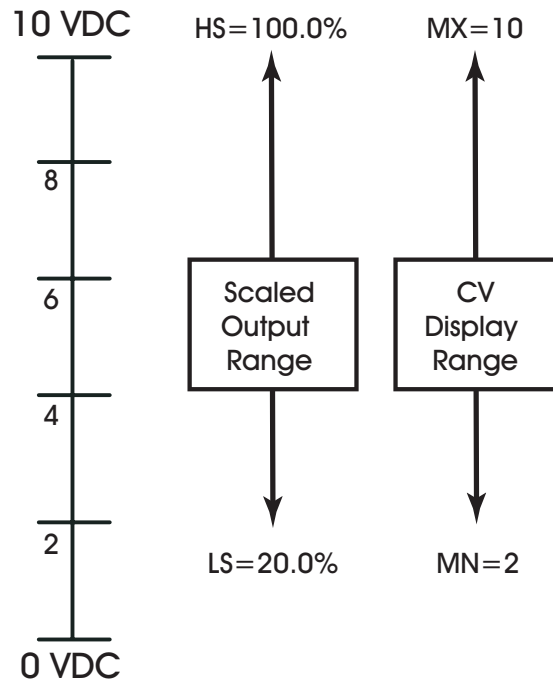

Figure 2-11: 2-10 V Displayed as a Voltage

Also, outputs can be configured to be reverse-reading. For a reverse-reading output, the value on **MN** is set greater than **MX**. For example, if a 4-20 mA output is controlling an actuator and if fully open at 4 mA and fully closed at 20 mA, you would set **LS**=20.0 (4mA = 20.0% x 20 mA) and **HS**=100.0 to specify the scaled output range. If you wanted to read the percentage that the actuator was open, you would set **MN**=100 and **MX**=0. This is shown in Figure 2-12. Here a fully closed actuator, output at 20mA, would read 0 and a fully open actuator, output at 4 mA, would read 100.

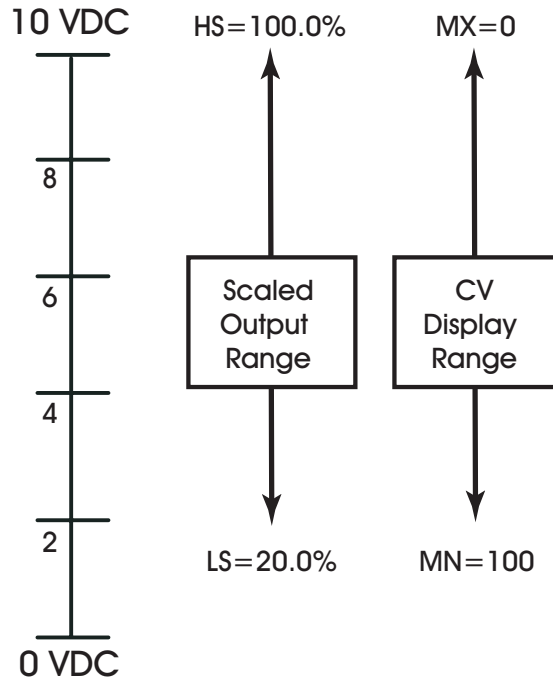

Figure 2-12:2 to 10 V Reverse Reading Input

If an output is set to manual control, the SBC-GPC3 gives you the option to have that output go to a pre-determined position if the communications are lost with a host that is controlling the output. If you wish to have the communications failure position for the output, you must first set the **CF** attribute to “Yes”. Then you should set the **FP** attribute. This specifies the desired position you wish the output to take in the event of a failure.

The SBC-GPC3 may also interlock the output to one or a number of inputs. This is used as a safety feature and can prevent equipment damage by immediately changing the output’s position when a fault is detected. To specify which inputs, configured as digital inputs, are to be used for interlocks, choose the appropriate inputs in the **IL** attribute, located in the Analog Output channel. A fault condition is generated when any of the specified inputs assumes the value specified by the **LP** for that input. When the interlock fault is detected, the output will assume the position specified in **FP**.

The SBC-GPC3 can also set the position of an output when a fire alarm is detected. If the SBC-GPC3 detects a fire alarm, the output will assume the position specified in the **FI** attribute.

2.6 DIGITAL OUTPUTS

The SBC-GPC3 has twelve (12) digital output channels which are exclusively for use with STATbus devices. They can be configured to make use of remote outputs on SSB-DO1, SSB-DO1-I, SSB-DO2, SSB-DO2-I and SSB-IOX1 modules.

Digital outputs are contacts that the SBC-GPC3 can open and close based on its control loops. These are used to control devices that are either on or off and do not have any intermediate values. Digital outputs can be controlled automatically by the SBC-GPC3 or they can have their outputs state set manually, either by the user or by a remote host or SPL program.

2.6.1 CONFIGURING DIGITAL OUTPUTS

The SBC-GPC3 gives you the option to have an output that it is being controlled by a remote host take a pre-determined state if the communications are lost with that host. If you wish to have the output revert to a communications failure position in the event communications are lost, you must enable the output in the **CF** attribute in the Digital Output Summary channel. The desired state you wish the output to take in the event of a failure is determined by the **FS** attribute in the Digital Output Summary channel. A check mark next to an output will cause that output to turn on in the event of a communications failure.

Using the Digital Output Summary channel, it is also possible to set the state you wish various outputs to take in the event of a fire. By selecting the outputs in the **FE** attribute you can specify which outputs you wish to set the state for when a fire alarm is detected. A check mark next to an output indicates that the SBC-GPC3 should set the state of that output to the state specified in the Fire Positions attribute (**FI**). For a complete description of the attributes in the Digital Output Summary channel, see Section 3.10, "Digital Output Summary, FB00".

For each digital output there are a number of attributes that are used to control how the output turns on and off and for how long. The SBC-GPC3 allows the user to specify an interval to wait after power is applied before the outputs are turned on. This is set using the **SI** attribute. This defines a wait period after power is applied, either initially or because of a power failure, before an output can be energized. This prevents outputs from snapping on upon powering up, before the controller's control loops have been given a chance to normalize.

You can specify a pulse width for the output using the **PW** attribute. This is a highly precise (nominally accurate to a tenth of a second) way to set the duration for which the output will be energized. This can be used for equipment that reads pulses of a certain duration as control signals.

Within the SBC-GPC3, it is also possible to set a runtime limit for the output. The **RH** attribute stores the number of hours that the output is energized (**CV=1**). After a predetermined amount of time specified in the **RL** attribute, a run limit alarm is generated. This is used to signal regular maintenance is required. For example, if a motor needed to be lubricated after 1000 hours of use, **RL** would be set to this limit (**RL=1000**) and would generate an alarm when **RH** exceeded the value of **RL**.

2.7 REMOTE I/O

The SBC-GPC3 is designed to work with STATbus expansion modules known as IOX modules which allow you to add remote inputs and outputs to the controller. This section gives a brief overview of how to connect and configure those devices. For more details, please refer to the IOX Modules User Manual, part #1E-04-00-0126.

2.7.1 CONNECTING DEVICES TO THE STATBUS

STATbus allows I/O devices to be located remotely from the controller. Devices physically located on the STATbus differ from conventional inputs and outputs only in how they must be connected to the SBC-GPC3. Instead of having a single input or output device wired to a pair of terminals on the controller, the STATbus allows for an open-topology network of devices to be created.

To use a STATbus device with the SBC-GPC3, you must start by connecting the twisted pair wire to be used for STATbus network communications to the terminals marked SSB and COM on the corresponding terminal block on the SBC-GPC3 (TB8, TB9, TB10, or TB11). These wires would then be connected to the two SSB terminals on the STATbus device. For STATbus devices which require power, the terminal labelled L1 and L2 can be used or an external power supply may be connected.

NOTE

Unlike the RS-485 network, STATbus connections have no polarity, meaning you need not concern yourself with maintaining polarity from one device to the next.

To connect additional devices, the wires are simply daisy-chained from the SSB terminals of the first device to the SSB terminals of the second device as shown in Figure 2-13.

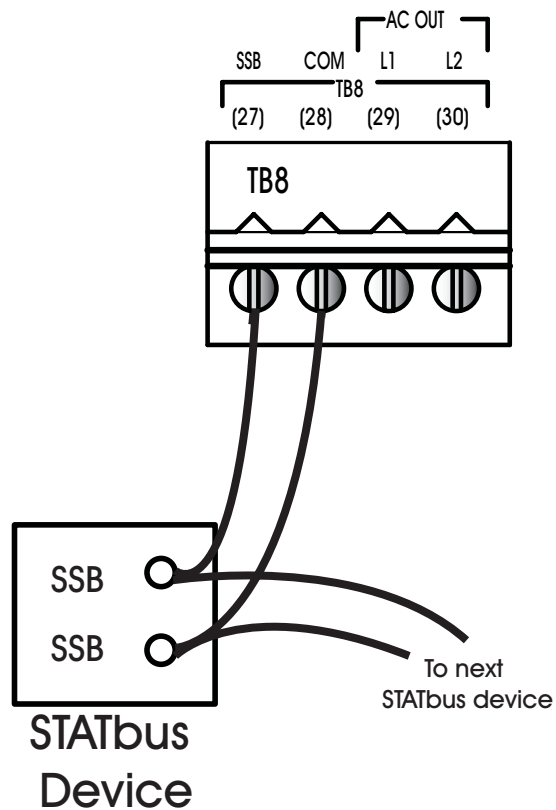

Figure 2-13: Connecting STATbus devices to the SBC-GPC3

2.7.2 LENGTH OF THE NETWORK

The distance measured from the controller to the STATbus device on the network located furthest away from it should not exceed 1000' in length. The STATbus shown in Figure 2-14a is a valid configuration because the distance from the controller to the most distant device is less than 1000' whereas the configuration shown in Figure 2-14b is not valid because the total length to the most distant device is 1150', exceeding the 1000' maximum.

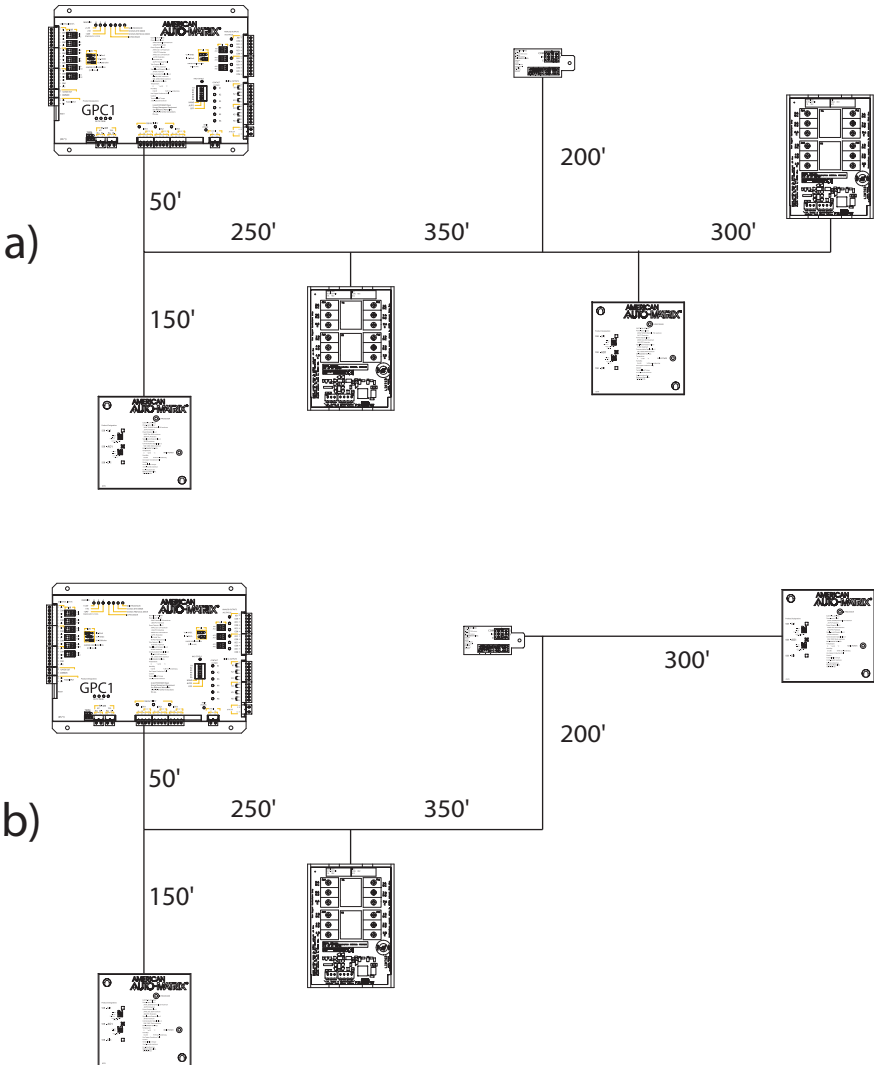

Figure 2-14 Determining Maximum STATbus Length

2.7.3 NUMBER OF DEVICES

Each STATbus channel on the controller will support a maximum of thirteen (13) devices.

CAUTION

A maximum of thirteen (13) devices can be connected to a single STATbus channel. If more than thirteen devices are connected, only thirteen will be enumerated by the controller. If more than thirteen devices are connected, there is no way to predict which devices will be enumerated and which will be left off.

2.7.3.1 COMMUNICATIONS LIMITS

While the STATbus protocol allows up to thirteen devices to be connected to a single network, certain devices reduce the maximum number of other devices that may be used on a single channel. In particular, STAT1D, STAT2D, and STAT3 have a higher power requirement than other STATbus devices and limit the total number of devices that can be put on the network and still communicate. When one or more STAT devices are included on the network, the maximum number of devices allowed on the network will be reduced.

NO STATs ON THE STATBUS

If your STATbus channel does not have any STATs (STAT1D, STAT2D, or STAT3) on it, then you may have up to thirteen devices in any combination on the network. This may include SSB-FI1s, SSB-UI1s, SSB-DI1s, SSB-AO1s, SSB-DO1s, SSB-DO1-Is, SSB-DO2s, SSB-DO2-Is, and SSB-IOX1s.

ONE OR MORE STATs ON THE STATBUS

If one or more STATs are being used, the total number of device that can communicate on a single STATbus channel will be reduced. Table 2-2 lists the number of additional STATbus devices that can be connected for a given number of STATs.

Table 2-2 Number of Devices Allowed on a STATbus

Number of STATs	Number of other STATbus Devices
1	11
2	9
3	7
4	5
5	2

EXAMPLE: NO STATs ON THE STATBUS

With no STATs on the Bus, you may use any combination of SSB devices, up to a maximum of thirteen devices total. This means any of the following would be valid:

- ▼ 13 SSB-FI1s to read a number of different inputs
- ▼ 6 SSB-FI1s and 6 SSB-AO1s to provide simple damper control for six zones

- ▼ 3 SSB-UI1s, 3 SSB-AO1s, and 3 SSB-DO1-Is, giving three zones with a zone temperature input, control for a damper and a reheat coil with supervisory monitoring

EXAMPLE: STATS ON THE STATBUS

For a STATbus design that contains STATS, you must refer to the Table 2-2 above to determine the number of devices that can be used in addition to the STATS.

For a system with 4 STATS, for example, Table 2-2 indicates that up to five additional devices can be connected to the bus. You could use four SSB-AO1s to create four zones with damper control.

NOTE

If you are implementing custom display sequences on STAT displays, AAM recommends that STATbus devices be distributed across available IOX connections whenever possible. This practice will provide higher reliability against erroneous pixelation.

2.7.4 POWERING STATBUS DEVICES

The connection for STATbus is a four pin connector with two pins for communication and two for optionally providing 24 VAC power to devices on the STATbus. This power output can eliminate the need for dedicated transformers for remote devices, allowing potentially faster, easier installation at a lower cost. If you plan to power STATbus devices using this output, you must be aware that there are limitations imposed by the ability to transmit that power to remote devices as well as the power capacity of the controller.

Though STATBus communication signals can be carried up to the network maximum of 1000' over 22 gauge cabling, due to power losses, this cable is not sufficient to transmit the 24 VAC used to power remote devices. For a longer network runs, the voltage drop across such a cable will leave less than the require voltage to operate many sensors and actuators. Therefore, when using devices which draw their power from the STATbus, you must use 18 gauge cabling to carry the power.

Using 18 gauge cabling to carry power, the controller should be able to provide the voltage and current necessary to operate most normal sensors, powered outputs, and smaller actuators. If you are using a large number of powered devices or devices which are known to have high power requirements, then you should supplement the power provided by the controller by using dedicated transformers one some of those units. Units with high power consumption would be the first candidates for dedicated transformers in this case.

You should never try to power large actuators using the STATbus as, in most cases, they simply require more power than the controller can provide. You should always use a dedicated power transformer when using these devices.

NOTE

The STATbus power outputs on the SBC-GPC3 controller are protected and are capable of providing a maximum of 24 VAC at 4 A before tripping the PTC. This is the total for all STATbuses on the device.

2.7.5 DISTRIBUTION OF DEVICES

Whenever possible, you should try to distribute your STATbus devices over all the available STATbus channels on the controller. For example, if you have a total of twelve STATbus devices connected to your controller, it is better to have 4 devices on each of the three STATbus channels than to have all twelve devices on a single channel. This reduces the communications load on any one STATbus channel and will result in better overall system performance.

2.7.6 MAPPING REMOTE I/O DEVICES TO CHANNELS

Because remote I/O devices are located away from the controller, there is an additional step of mapping these remote points back to the controller so that the SBC-GPC3 may recognize them. Once these I/O devices are mapped, they behave the same as an input or output point that is physically located on the SBC-GPC3.

To map a STATbus device to an input or output, you will need to assign the device's global identification (GID) number to the input or output. To do this, you must perform the following steps.:

1. Set FF00;CR = "Edit I/O GIDs" to allow the GPC to edit configuration information.
2. Set the **GI** attribute of the desired input or output to the GID of the device to be assigned.
3. Configure the attributes associated with the input or outputs, i.e. **ST**, **MN**, **MX**, **ON**, etc.
4. If additional device need to be assigned, repeat steps 2 and 3 until all devices are assigned.
5. Set FF00;CR = "GPC to Bus" to write the configuration information to the device(s).

Some IOX modules have more than one input or output of a given type. This can lead to confusion when assigning the GID number for these modules because all inputs and outputs on an IOX module have the same GID number.

NOTE

All input and output points on an IOX module have the same GID number.

If the IOX module has more than one input or output point, assigning its GID number to the **GI** attribute of a channel will cause the GID number to be assigned to the **GI** attribute of a number of consecutive input or

output channels equal to the number of points of that type on the module, starting with the channel in which the GID was entered. For example, if the GID of an IOX module with four universal inputs was assigned to UI16, that GID number would automatically be assigned to UI17, UI18 and UI19 as well, erasing any previous assignments. For example, if a STATbus device had previously been assigned to UI18, it's GID would be overwritten with the GID of the IOX module. This can cause previously configured inputs to have their configuration information overwritten.

CAUTION

Assigning the GID number of an IOX module with more than one input or output may cause the mapping of previously assigned STATbus devices to be lost.

When GID number of IOX modules with multiple inputs or outputs are assigned, the lowest numbered input or output will correspondingly be mapped to the lowest numbered channel. In the previous example, the first input on the IOX module would be mapped to UI16, the second to UI17, the third to UI18, etc.

Once the GID number has been assigned, the Configure Remote I/O attribute should be set to "GPC to Bus". This will write the configuration information to the remote I/O device. Once the data has been written, the GPC will return to "Normal" mode.

NOTE

The GID number **must** be assigned and written to the remote I/O device before any other configuration is performed.

With the device now mapped to the channel, the input or output can be configured normally (i.e., setting the sensor type, defining any minimums or maximums, configuring alarming, etc.).

SECTION 3: CHANNEL & ATTRIBUTE DESCRIPTIONS

This section describes the channels and attributes in the SBC-GPC3 and explains how to they are used.

IN THIS SECTION

System, FF00.....	3-3
STATbus 1-4, FF01-FF04	3-11
Universal Input Summary, FE00	3-13
Universal Inputs 1-24, FE01-FE18.....	3-16
Digital Input Summary, FE30	3-25
Digital Input, FE31-FE38.....	3-27
Occupancy Detector, FC01	3-31
Analog Output Summary, FD00	3-33
Analog Outputs 1-12, FD01-FD0C.....	3-35
Digital Output Summary, FB00.....	3-38
Digital Outputs 1-12, FB01-FB0C	3-42
PID Control 1-12, FA01-FA0C.....	3-46
Thermostatic Control 1-12, FA11-FA1C	3-59
Floating Point Control 1-2, FA21-FA22	3-63
Schedule Summary, F900.....	3-78
Schedules 1-8, F901-F908	3-82
Scales 1-4, F711-F714.....	3-86
Piecewise Curves 1-2, F701-F702.....	3-88
Math 1-2, F311-F312.....	3-92
Averages 1-3, F301-F303	3-95
Logic 1-4, F321-F324.....	3-97
Program Summary, F200.....	3-100
Programs 1-8, F201-F208.....	3-103
Input Select 1-4, F011-F014.....	3-106
Broadcast 0-7, F000-F007	3-108

3.1 SYSTEM, FF00

The System channel is used to control and configure a number of general controller features of the SBC-GPC3. The System channel is divided into a number of sub-channels in SoloPro. These sub-channels are About, Power-Up, Network Configuration, and Setup. The System channel contains the following attributes: **ON, EM, SN, CT, VE, FT, FC, SR, CM, FA, OS, PD, PS, DE, RS, ID, ZN, CP, CF, TP, ER, U1, U2, U3, U4, TM, DT, DA, DS, RD, RM, ND, NM, ST, ET, TF, BA, BF, BS, BT,** and **CR**.

3.1.1 ABOUT

The About sub-channel contains information about the SBC-GPC3. This is the place where the controller manufacturer (**CM**), controller type (**CT**), and serial number (**SN**) can be found. It is also where the firmware version (**VE**) and type (**FT**) along with the flash release code (**SR**) and the flash update count (**FC**) will be found.

Attribute **ON** is a user definable string that can be used to help identify the channel or, in the case of the System Channel, the controller itself or its location. This can be helpful if multiple controllers are on the same network. In this case, **ON** can be used to quickly identify each one.

Attribute **EM** is used to specify the engineering units to be used by the controller. Using this attribute the SBC-GPC3 can be set to operate using either english or metric units.

Attribute **SN** stores the controller's serial number. This number is set at the factory and cannot be changed.

Attribute **CT** attribute identifies the factory-set controller type number for the controller. **CT** for the SBC-GPC3 is 105.

The firmware version attribute, **VE**, identifies the firmware that is currently installed on the SBC-GPC3. This number is checked when flashing updates to determine if updates are available.

The version of the kernel, **OS**, running within the controller is also displayed in the system channel.

The System channel also keeps a record of the firmware type installed in the controller. This information is stored in attribute **FT**. For the SBC-GPC3, **FT** will be equal to 9.

When the firmware is updated by flashing the controller, the flash update count attribute, **FC**, is incremented. This keeps track of the total number of times the controller has been flashed. Also, when the controller is flashed, it stores the release code for the firmware in attribute **SR**. **FC** and **SR** are used primarily as diagnostic and troubleshooting tools.

Attribute **CM** identifies the factory-set manufacturer number for the controller. **CM** for American Auto-Matrix controllers is always 255.

Any faults that are detected are displayed in attribute **FA**. **FA** is the Faults Detected attribute. When a fault is detected, a check mark will appear next to the corresponding fault. If no fault is detected, no check marks will be displayed. If a fault is detected, the controller can be configured to broadcast that information to other units on the network. The faults displayed in **FA** are fire, emergency, and communication failure.

Attribute **OS**, shows the current version of the kernel.

3.1.2 POWER-UP

Attribute **PD** specifies the control and alarm power-on delay. This is the time delay (in seconds) that must elapse after the controller is reset before it begins control and alarming functions.

Attribute **PS** defines the power-up state of the SBC-GPC3. This is the schedule state that the controller will operate in when it is first powered up or after power is restored following a power failure. The possible states in which the controller can start up are unoccupied, warmup, occupied, or night setback.

The default enable attribute, **DE**, is used if you wish to return the SBC-GPC3 to the factory default values for all attributes. Setting **DE=197** will immediately clear all attributes and return them to their default values. Setting **DE=197** also clears all the programs loaded into the SBC-GPC3.

If you wish to reset the SBC-GPC3, the reset attribute, **RS**, must be set to "Yes". When the controllers is reset, the processor is reset, clearing the memory and stopping any programs that are running. **RS** then returns to a value of "No".

3.1.3 NETWORK CONFIGURATION

The **ID** attribute is the unit ID number. This is a number that uniquely identifies the controller on the network. Each controller must have a unique **ID** or communications problems will occur. The value of **ID** defaults to the last four digits of the unit's serial number.

Broadcasts sent from the SBC-GPC3 can be set to either broadcast globally or to a specific zone. This is specified in the appropriate Broadcast channel. If zone broadcast is enabled then the broadcasts will be sent to all of the units with the same zone number (**ZN**) as the SBC-GPC3. The zone number attribute, **ZN**, is a number (from 0 to 65,535) used to group controllers so that they may be controlled together and can communicate exclusively with each other, if that is desired.

A number of the SBC-GPC3's communications parameters are defined in the System channel. The communication rate is define by attribute **CP**. The communication baud rates available in the SBC-GPC3 are 9600, 38.4k, 19.2k, 57.6k and 115.2k.

Along with a baud rate, a communications timeout must be specified. This is the amount of time that the controller will wait to be polled before entering a communication fault state. The communications failure timeout, given in seconds, is specified by attribute **CF**. If the communications timeout is exceeded, a communication fault will be generated and **FA** will be set to "Comm Failure". This only needs to be set if a host or peer controller has an SPL program controlling the SBC-GPC3's outputs.

Once the communication parameters have been defined, the SBC-GPC3 can be configured to operate on the network. First the token passing type should be set using attribute **TP**. The SBC-GPC3 can operate as either as an irresponsible peer or as a full administrator. As a full administrator, the controller will administer the token between itself and up to four peer units who's ID numbers are specified in attributes **U1** through **U4**. When the SBC-GPC3 is set to full administrator, it should also be configured to enable token error recovery using the **ER** attribute. When error recovery is enabled, the controller will detect when the token has been lost and will re-initiate communications by sending a new token onto the network. If the SBC-GPC3 is configured as an irresponsible peer, then error recovery is not used and can be disabled.

3.1.4 SETUP

The System channel has registers for a number of system attributes such as the current time (**TM**), the current date (**DT**) and the current day of the week (**DA**). The current time is displayed in the **TM** attribute and takes the format HH:MM. The current dates is stored in **DT** and has the from MM/DD/YYYY. The day

of the week attribute, **DA**, indicates the day of the week.

The SBC-GPC3 can be adjusted for daylight savings time. To configure daylight savings, you must specify when daylight savings time begins and ends. The starting day is specified in the **(RD) Daylight Saving Start Day** attribute. The options for **RD** are given in Table 3-1.

Table 3-1 : Daylight Savings Start Day

RD	Day of the Week
0	None
1	First Sunday
2	First Friday
3	Second Saturday
4	Third Sunday
5	Third Saturday
6	Last Sunday
7	Last Thursday
8	Last Friday

Once the starting day has been set, you must specify the month in which daylight savings time begins. The month is chosen using the **(RM) Daylight Saving Start Month** attribute. The option for **RM** are given in Table 3-2.

Table 3-2 : Daylight Savings Start Month

RM	Month
0	None
1	January
2	February
3	March
4	April
5	May
6	June
7	July
8	August
9	September
10	October
11	November
12	December

The end of daylight savings time is specified in a very similar manner. The day on which daylight savings time ends is specified in the **(ND) Daylight Saving End Day** attribute. The options for **ND** are given in Table 3-3.

Table 3-3 : Daylight Savings End Day

ND	Day of the Week
0	None
1	First Sunday
2	First Friday
3	Second Saturday
4	Third Sunday
5	Third Saturday
6	Last Sunday
7	Last Thursday
8	Last Friday

The month in which daylight saving time ends is specified in the **(NM) Daylight Saving End Month** attribute. The options for **NM** are given in Table 3-4.

Table 3-4 : Daylight Savings End Month

NM	Month
0	None
1	January
2	February
3	March
4	April
5	May
6	June
7	July
8	August
9	September
10	October
11	November
12	December

The time at which daylight savings time begins is specified in the **(ST) Daylight Saving Start Time** attribute.

The time at which daylight savings time ends is specified in the **(ET) Daylight Saving End Time** attribute.

When the current date **(DT)** is after the daylight savings start time **(ST)** on the daylight saving start day **(RD)** and is before the daylight savings end time **(ET)** on the daylight saving end day **(ND)** then the **(DS) Daylight Saving Status** attribute will be set to "Yes" (**DS=1**).

The SBC-GPC3 has a number of broadcast capabilities that are controlled by the System channel. Some of these are triggered by faults detected by the SBC-GPC3. By setting the appropriate attributes, the SBC-GPC3 can broadcast alarms **(BA)**, change to fire mode commands **(BF)** or time synchronization signals **(BS)**. The frequency with which these broadcasts are repeated can be controlled by the broadcast time interval attribute **(BT)**.

If the broadcast alarms attribute is enabled (**BA=1**), then the SBC-GPC3 will broadcast to the network that an alarm has been generated within the controller. This broadcast can be received by other controllers and can lead to further control actions.

NOTE

If SBC-GPC3 is configured to broadcast alarms, then no other devices on the network should be configured to poll for alarms. You may either broadcast alarms or poll for alarms, but not both.

If a fire condition is detected, either by the SBC-GPC3 itself or as a result of a fire broadcast from another controller on the network, the controller will switch into a fire mode **(FA, bit #0=1)**. It will stay in fire mode for an amount of time specified in attribute **TF**. The SBC-GPC3 can broadcast the fact that it has entered a fire mode to other units on the network. If the broadcast fire attribute is enabled (**BF=1**) then a broadcast will be sent when the SBC-GPC3 when a fire condition is detected (**FA, bit #1=1**).

The SBC-GPC3 also has the ability to synchronize the time of other units on the network. This is accomplished by enabling the broadcast time sync attribute (**BS=1**). The time between each broadcast, in minutes, is specified in **BT**. When time synchronization is selected, the current time **(TM)** will be broadcast once every **BT** minutes when the SBC-GPC3 has the token.

Attribute **CR** defines how remote I/O devices on STATbus channels are configured. The possible values of **CR** are listed in Table 3-5

Table 3-5 : Remote I/O Configuration Options

CR	Option
0	Normal
1	GPC to Bus
2	Edit I/O GIDs
3	GPC from Bus

When remote I/O configuration is set to Normal mode (**CR=0**), editing I/O configuration attributes (**ST, RE, HL**, etc.) will update the configuration information in the remote I/O device.

When **CR=1**, The SBC-GPC3 writes all of the channel I/O configuration data to the STATbus devices in one atomic (unstoppable) write. The controller then reverts to Normal mode upon completion. This would be used if you wanted to configure the SBC-GPC3 offsite. All of the assignments and configurations could be made before the SBC-GPC3 was installed and then **CR** could be set to 1 to write all of the configuration information to the STATbus devices which had already been installed.

If **CR=2**, the SBC-GPC3 will operate in GID Edit mode. In this mode, there is no reading, writing or configuration of I/O done by the controller. This mode is used to designate STATbus devices for use as inputs and outputs. None of the changes made while in edit mode are sent to the STATbus remote I/O devices until the "GPC to Bus" option is selected.

CR=3 is very similar to **CR=1**, except that the SBC-GPC3 reads all of the channel I/O configuration data from the STATbus devices in one atomic (unstoppable) read. The controller reverts to Normal mode upon completion. This would be used if all of the STATbus devices were already configured but the SBC-GPC3 did not have that information. This would occur, for example, if a SBC-GPC3 in the field were replaced by a different unit or if the controller had all of its attributes reset to their default values.

System, FF00

Attribute	Description
About	
ON	GPC Name specifies a user definable string that is used to help identify the channel or its function.
EM	Engineering Units specifies the units to be used when returning values 0=English 1=Metric
SN	Serial Number the factory-set serial number.
CT	Controller Type factory-set controller type number for the controller. CT for the SBC-GPC3 is 105.
VE	Firmware Version contains the version of the controller's firmware.
FT	Firmware Type indicates which firmware is installed on the controller 7=GPC1 8=GPC2 9=GPC3
FC	Flash update count indicates the number of times the controller has been flashed.
SR	Flash Release Code the release code of the firmware currently flashed on the controller, used primarily for technical support purposes.
CM	Manufacturer indicates the factory-set manufacturer number for the controller. (CM for American Auto-Matrix controllers is always 255)
FA	Faults Detected a bitmap indicating the current fault conditions. bit 0=Fire bit 1=Emergency bit 5=Communications failure
OS	Kernel Version indicates the version number of the kernel.
Power-up	
PD	Power-Up Delay time delay (in seconds) that must elapse after the controller is reset before it begins control and alarming functions. 5-255=# of seconds Default value is 15.

Attribute	Description
PS	Power-up state schedule state that the controller will operate in when it is first powered up or after power is restored following a power failure. 0=unoccupied 1=warmup 2=occupied 3=night setback
DE	Default Enable used to return all attributes in the controller to their default values. 0=Normal operation 197=set attributes to their default values.
RS	Reset the Controller? used to reset the controller. Setting RS to 1 resets the controller. 0=No 1=Yes
Network Configuration	
ID	Unit Number (ID) specifies the controller's identification number. The value of ID defaults to the last four digits of the unit's serial number.
ZN	Zone Number a number (from 0 to 65,535) used to group controllers so that they may be controlled together.
CP	Communication Speed the rate at which the controller communicates. 0=9600 6=38400 7=19200 8=115.2k 9=57.6k
CF	Communication Failure Timeout specifies the amount of time, in seconds, that the controller will wait to be polled before entering a communication fault state.
TP	Token Passing Type defines the mode for token passing. 0=Irresponsible Peer 1=Full Administrator
ER	Token Recovery? If Token Error Recovery is enabled and a token is lost, Full Administrator will detect the condition and initiate a new token. 0=Disabled 1=Enabled
U1	Peer Unit Number specifies the unit number (ID) for the first peer unit on the network. ID is set to 65,535 if there is no peer.
U2	Peer Unit Number specifies the unit number (ID) for the second peer unit on the network. ID is set to 65,535 if there is no peer.

Attribute	Description
U3	Peer Unit Number specifies the unit number (ID) for the third peer unit on the network. ID is set to 65,535 if there is no peer.
U4	Peer Unit Number specifies the unit number (ID) for the fourth peer unit on the network. ID is set to 65,535 if there is no peer.
Setup	
TM	Current Time indicates the current time in the form HH:MM.
DT	Current Date the current date displayed as MM/DD/YYYY
DA	Day of Week the current day of the week 0=Monday 1=Tuesday 2=Wednesday 3=Thursday 4=Friday 5=Saturday 6=Sunday
TF	Time to Remain in Fire Mode The time (in minutes) that the controller will remain in fire mode.
BA	Broadcast Alarms? specifies whether alarms are to be broadcast over the network 0=No 1=Yes
BF	Broadcast Fire? specifies whether the "change to fire mode" command should be broadcast 0=No 1=Yes
BS	Broadcast Sync Time? specifies whether to broadcast time synchronization information 0=No 1=Yes
BT	Broadcast Time Interval specifies the time (in minutes) between network broadcasts
CR	Configure Remote I/O specifies options for the configuration of remote I/O device located on the STATbus. 0=Normal 1=GPC to bus 2=Edit I/O GIDs 3=GPC from bus

3.2 STATBUS 1-4, FF01-FF04

The SBC-GPC3 is capable of using up to a total of thirteen STATbus devices connected to each of its four STATbus ports. Each of these ports has an associated STATbus channel. These channels are used to monitor the status of the STATbus network and the devices connected to it. Each STATbus channel has the following attributes: **ON**, **G1**, **G2**, **G3**, **G4**, **G5**, **G6**, **G7**, **G8**, **G9**, **GA**, **GB**, **GC**, **GD**, **CD**, **CF**, **BS**, and **SM**.

Attribute **ON** stores the name of the channel. This is a user definable string that can be used to help identify the channel.

Attributes **G1** through **GD** store the global identification numbers of the devices attached to the STATbus network. After the SBC-GPC3 has enumerated all of the STATbus devices attached to the associated STATbus channel, the global identification numbers will be assigned to an internal routing table and then displayed in **G1** through **GD**. These values are read only.

Attribute **CD** is used with **CF** to help in field configuration of STATbus devices. The device you wish to configure is selected by entering its GID number into **CD**. **CF** can then be used to locate a specific STATbus device in the field by causing an LED on the device to blink (**CF**="1").

The overall status of the STATbus can be monitored using the bus status attribute **BS**. If the STATbus channel is functioning properly, is configured and is not experiencing an error, **BS** will equal 0. When **BS**=1, it indicates that the network needs to be configured. This means that a remote I/O device has been physically added and recognized by the SBC-GPC3, but has not yet been assigned to a channel. If the SBC-GPC3 encounters an error on the STATbus, **BS** will take a value of 2.

The (**SM**) Status Map attribute is a bitmap which displays information about the current status of the STATbus. Bit 0 of **SM** is not used.

Bit 1 will be 1 if there is an unconfigured device on the network.

Bit 2 will take a value of 1 if there are duplicate configurations on the network. This could occur, for example, if an SSB-F11 configured as UI14 was added to a network which already had a device configured as UI14.

Bit 3 indicates that the power level on the STATbus is low. It is used to determine if the bus is shorted, or loaded down to the point that it will function. When a STATbus network is heavily loaded, the power drawn by the devices may be so great as to disrupt communications. This can lead to devices not enumerating correctly or dropping communications. STAT3 devices are especially susceptible to this effect as they require additional power for the screen.

Bit 4 indicates that a re-enumeration has occurred.

In SoloPro, there are the "UI GIDs", "DI GIDs", "AO GIDs", and "DO GIDs" tabs which provide centralized access to the **GI** properties for channels FE01-FE18, FE31-FE38, FD01-FD0C, and FB01-FB0C, respectively. These 'GID summary' channels are provided you with a single place to view all STATbus assignments as well as to allow you to conveniently make those assignments. The FF00;**CR** attribute is also included at the bottom of the GID summary tabs to eliminate the need to navigate back to the Setup tab in the System channel every time you wished to read or write STATbus configuration information.

STATbus 1-3, FF01-FF03

Attribute	Description
ON	StatBus Name specifies a user definable string that is used to help identify the channel or its function.
G1	GID Device 1 indicates the global identification number of device 1.
G2	GID Device 2 indicates the global identification number of device 2.
G3	GID Device 3 indicates the global identification number of device 3.
G4	GID Device 4 indicates the global identification number of device 4.
G5	GID Device 5 indicates the global identification number of device 5.
G6	GID Device 6 indicates the global identification number of device 6.
G7	GID Device 7 indicates the global identification number of device 7.
G8	GID Device 8 indicates the global identification number of device 8.
G9	GID Device 9 indicates the global identification number of device 9.
GA	GID Device 10 indicates the global identification number of device 10.
GB	GID Device 11 indicates the global identification number of device 11.
GC	GID Device 12 indicates the global identification number of device 12.
GD	GID Device 13 indicates the global identification number of device 13.
CD	Configure Device (GID) used to specify a specific STATbus device that will be used with CF.
CF	Configure Function 0=Disabled 1=Blink LED
BS	Bus Status indicates the status of the SMARTStat Bus. 0=Ok 1=Needs configured
SM	Status Map bit #1=Unconfigured device on network bit #2=Duplicate configuration on network bit #3=Low power bit #4=Re-enumeration occurred

3.3 UNIVERSAL INPUT SUMMARY, FE00

The Universal Input Summary channel is a convenient way to monitor the states and many of the options for the universal inputs on the SBC-GPC3. From this channel, you can check the current values (**V1-V0**) as well as the channel reliabilities (**RE**) for each universal input. This channel will also display any inputs that are currently overridden (**OI**). The input polarities (**IP**) as well as the interlock polarities (**LP**) for each channel will also be displayed. The Universal Input Summary channel has the following attributes: **ON, V1, V2, V3, V4, V5, V6, V7, V8, V9, VA, VB, VC, VD, VE, VF, VG, VH, VI, VJ, VK, VL, VM, VN, VO, RE, IP, LP, OI, PU, PS, PI, and AT**.

Attribute **ON** stores the name of the channel. This is a user definable string that can be used to help identify the channel or its function.

Attributes **V1** through **VO** display the current measured of inputs 1 through 24, respectively. Each value is displayed separately.

Each channel's reliability is displayed in attribute **RE**. This bitmap indicates which inputs have readings that are considered reliable. Inputs considered to be reliable inputs will have the corresponding bit in **RE=0** while unreliable ones will have the corresponding bit in **RE=1**.

Attribute **IP** displays the input polarities. Each bit of **IP** specifies how the controller internally represents the corresponding input when it is configured as a digital input. When an input is set to normal polarity (**IP=0**), low voltage is displayed as **CV=0** and high voltage is displayed as **CV=1**. If, however, the polarity is set to reverse polarity (**IP=1**), then low voltage will be displayed as **CV=1** and high voltage as **CV=0**.

Attribute **LP** displays the interlock polarities. Each bit of **LP** indicates the individual interlock polarity states for the corresponding universal input configured as a digital input. For normal operation (**LP=0**), the corresponding digital input is considered to be normal when **CV=0**. When the corresponding bit is configured for reverse operation (**LP=1**), then the input will be considered normal when **CV=1**.

Similarly, attribute **OI** displays which attributes are currently overridden. If an input is overridden, the corresponding bit in **OI** will be set equal to 1. If the input is reading normally, the corresponding bit in **OI** will be set to 0.

Attributes **PU, PS, and PI** are used to set the P.I.N. numbers used when the universal input is configured for use with a SMARTStat (FE0x;ST=9). **PU** sets the P.I.N. number needed to unlock the User menu, **PI** sets the P.I.N. number needed to unlock the Installer menu, and **PS** sets the P.I.N. number needed to unlock the Service menu. All passwords are four digit numbers that are entered using the buttons on the STAT. Setting **PU, PS, or PI** to 0 allows users to access the respective menu without having to enter a P.I.N. number.

Attribute **AT** is the alarm limit setup/setback time delay. **AT** specifies the time, in minutes (0-255), that must elapse after an input following a schedule makes a transition to occupied mode before alarm limits are no longer setup/setback. If a universal input has alarming enabled (FE0x;AE>0), has an alarm limit setup/setback offset specified (FE0x;SU>0.0), and is under schedule control (FE0x;SM>0), then the input's alarm limits will remain setup/setback for **AT** minutes after the schedule indicates a changeover from unoccupied to occupied mode. If **AT=0** minutes, the input's alarm limits will be returned to their normal occupied values as soon as the schedule indicates the change from unoccupied to occupied mode.

Universal Input Summary, FE00

Attribute	Description
ON	Universal Inputs Summary Name specifies a user definable string that is used to help identify the channel or its function.
V1	Current Measured Input 1 Value indicates the current measured value of input 1.
V2	Current Measured Input 2 Value indicates the current measured value of input 2.
V3	Current Measured Input 3 Value indicates the current measured value of input 3.
V4	Current Measured Input 4 Value indicates the current measured value of input 4.
V5	Current Measured Input 5 Value indicates the current measured value of input 5.
V6	Current Measured Input 6 Value indicates the current measured value of input 6.
V7	Current Measured Input 7 Value indicates the current measured value of input 7.
V8	Current Measured Input 8 Value indicates the current measured value of input 8.
V9	Current Measured Input 9 Value indicates the current measured value of input 9.
VA	Current Measured Input 10 Value indicates the current measured value of input 10.
VB	Current Measured Input 11 Value indicates the current measured value of input 11.
VC	Current Measured Input 12 Value indicates the current measured value of input 12.
VD	Current Measured Input 13 Value indicates the current measured value of input 13.
VE	Current Measured Input 14 Value indicates the current measured value of input 14.
VF	Current Measured Input 15 Value indicates the current measured value of input 15.
VG	Current Measured Input 16 Value indicates the current measured value of input 16.
VH	Current Measured Input 17 Value indicates the current measured value of input 17.
VI	Current Measured Input 18 Value indicates the current measured value of input 18.
VJ	Current Measured Input 19 Value indicates the current measured value of input 19.

Attribute	Description
VK	Current Measured Input 20 Value indicates the current measured value of input 20.
VL	Current Measured Input 21 Value indicates the current measured value of input 21.
VM	Current Measured Input 22 Value indicates the current measured value of input 22.
VN	Current Measured Input 23 Value indicates the current measured value of input 23.
VO	Current Measured Input 24 Value indicates the current measured value of input 24.
RE	Inputs with Unreliable Channels indicates whether the reading from the corresponding input is considered reliable. 0=Reliable 1=Unreliable RE is a bitmap with bit 1 corresponding to UI1, bit 2=UI2, etc. up to bit 24=UI24.
IP	Input Polarities specifies how the controller represents the input internally. 0=Normal polarity. Low Voltage is displayed as CV =0 and High Voltage is displayed as CV =1. 1=Reverse polarity. Low Voltage is displayed as CV =1 and High Voltage is displayed as CV =0. IP is a bitmap with bit 1 corresponding to UI1, bit 2=UI2, etc. up to bit 24=UI24.
LP	Interlock Polarities indicates the individual interlock polarity states for each UI. 0=Normal 1=Reverse LP is a bitmap with bit 1 corresponding to UI1, bit 2=UI2, etc. up to bit 24=UI24.
OI	Overridden Inputs allows the current value of the corresponding input, V1 through VO, to be overridden. 0=Normal 1=Override OI is a bitmap with bit 1 corresponding to UI1, bit 2=UI2, etc. up to bit 24=UI24.
PU	User P.I.N. specifies the P.I.N. code used to enter the User menu.
PS	Service P.I.N. specifies the P.I.N. code used to enter the Service menu.
PI	Installer P.I.N. specifies the P.I.N. code used to enter the Installer menu.

Attribute	Description
AT	Alarm Limit setup/setback time delay the time (in minutes) that must elapse after transitions from occupied to unoccupied or from unoccupied to occupied before alarm limits return to their previous (pre-setup/setback) values.

3.4 UNIVERSAL INPUTS 1-24, FE01-FE18

The Universal Input channels specify the configuration and scaling information for each of the universal inputs on the SBC-GPC3. The attributes in each Universal Input channel are identical. Each Universal Input channel has the following attributes: **ON, AE, AS, AD, CV, DT, HL, HS, IF, IP, LL, MN, MX, OI, RE, RH, RL, SM, ST, SU, GI, ED, ER** and **OF**.

Attribute **ON** stores the name of the channel. This is a user definable string that can be used to help identify the channel or, for example, the type of sensor connected to the input or the sensor's location.

Attribute **CV** displays the current measured input value of the associated universal input. **CV** will have a datatype specified in **DT**.

Attribute **RE** displays the channel reliability. **RE** indicates whether an input is questionable. An input is considered questionable if it is outside of its range. A good example of this would be a 4-20 mA sensor. Sensor readings from 0-4 mA would be considered questionable because the sensor should normally never have a reading in that range. In this case, the controller would clamp the readings below 4 mA at 4 mA and set the corresponding reliability attribute to questionable (**RE=1**). In the case of a digital input, the reliability can still be questionable. **RE** will be set equal to 1 while the input filter delay (**IF**) elapses or in the event of a communications failure when a host is controlling the state of the output.

Attribute **ST** specifies the type of sensor connected to the input. **ST** lets you define the type of sensor as well as the type of scaling to be used when displaying the current value (**CV**) for that sensor. The available types of sensors that can be used with the SBC-GPC3 are listed in Table 3-6.

Table 3-6 : Sensor Types

ST	Sensor Type
0	Digital
2	MN..MX 0 to 5V
3	MN..MX 4 to 20mA
4	Curve 1
5	Curve 2
6	MN..MX 0 to 10V
7	Thermistor -30.0 to 230.0
8	MN..MX 0 to 20mA
9	SmartStat Temperature
10	SmartStat Humidity

When the input is configured as a digital input (**ST=0**), the value of **CV** (either 0 or 1) is determined by the value of the input voltage with respect to a voltage threshold and input polarity **IP**. An input filter delay (**IF**) is included to minimize the bouncing that may occur with digital inputs.

For linear, analog input devices that operate in the range 0-5 V (**ST=2**), 4-20 mA (**ST=3**), 0-10 V (**ST=6**), or 0-20 mA (**ST=8**) the minimum and maximum values are scaled to **MN** and **MX** respectively. For example, if you wanted a 0-10 V input to be displayed as a percentage, you would set **MN=0** and **MX=100**. The

controller would then scale the raw counts (0-16,777,215) to the range 0-100. Here zero counts would correspond to a value of **CV**=0 and 16,777,215 counts would correspond to a **CV**=100.

NOTE

By making the value of **MN** greater than **MX**, you can configure the input for reverse scaling.

The SBC-GPC3 is also capable of handling nonlinear sensor types. The most common type of non-linear sensor is a precon-type 3 thermistor. When the input is configured as a thermistor input (**ST**=7), it is assumed to be a precon-type 3 thermistor with a range of -30° to 230° F. The scaling for this type of input is performed using a built in table that is automatically referenced when this sensor type is selected.

If a different type of non-linear sensor is needed, it is possible to use one of the Piecewise Curve channels to scale the input (**ST**=4 or **ST**=5). This option works much like the thermistor input, but instead of referencing a built-in table, the table that correlates input counts to an output value is defined in the Piecewise Curve channel.

Attribute **DT** determines how certain attributes will display their values. Datatype codes determine the number of decimal places in the value, and whether it is signed (positive or negative) or unsigned. **DT** affects the display of **CV**, **MN**, **MX**, **LL**, **HL**, **HS** and **SU**. A complete list of the available PUP datatypes are given in Appendix C: PUP Data Types. The default value for **DT** is 254 (unsigned 10 digit).

Attribute **DF** is used to determine how a STAT associated with the Universal Input will display the temperature. You have the option to include one decimal place in the display or simply display the nearest integer value for the temperature. Also, you can choose to display a degree symbol or a degree symbol and either a capital "F" or a capital "C" depending on the engineering units selected. The display options for **DF** are given in Table 3-7.

Table 3-7 : Display Formats

DF	Display Format
0	##°
1	##.#°
2	##°F
3	##.#°F
4	None

Attribute **TM** specifies the magnitude of the user setpoint offset. Each press of the up or down buttons on a stat will increment the setpoint by an amount **TM**. There are five steps above and below the setpoint, providing for a maximum offset amount of 5 x **TM** above or below the setpoint.

Attributes **MN** and **MX** define the minimum and maximum scaled values, in Engineering Units, for the associated input configured to operate as a linear analog input (**ST**=2,3,6, or 8).

Attributes **LL**, **HL**, **HS**, **AS**, **AE** and **SU** provide the controller with alarming capability for the associated input.

Attributes **LL** and **HL** are the low- and high-alarm limits. They define the high and low limits for alarming on the analog input. The datatype for both of these attributes is determined by **DT**. If the value of the analog input (**CV**) rises above the high alarm limit (**HL**) then a high limit alarm will be generated. Similarly, if the value of the analog input (**CV**) falls below the low alarm limit (**LL**) then a low limit alarm will be generated.

Attribute **HS** defines an alarm limit hysteresis. This value determines when the controller returns from a high- or low-alarm limit alarm condition. If the controller is currently in a high limit alarm, then the current value, **CV**, must drop below **HL** by an amount **HS** before a limit return is generated. Similarly if the controller is in a low limit alarm, then the current value, **CV**, must rise above **LL** by an amount **HS** before controller function returns to normal. The effects of **LL**, **HL**, and **HS** are shown in Figure 3-1. The SBC-GPC3 provides the option to setup or setback the alarm limits during unoccupied periods when control can be less stringent.

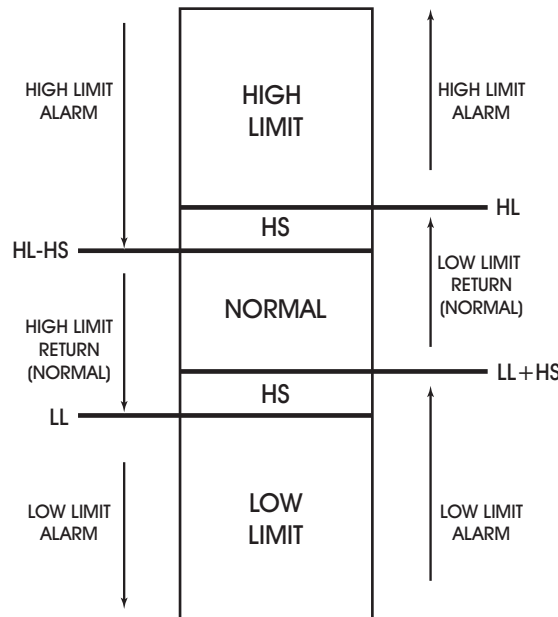

Figure 3-1: Alarm States and Thresholds for Alarming

The alarm status attribute, **AS**, displays the current alarm state for the input corresponding to each universal input channel. The possible values for **AS** are Normal, Contact 0 > 1, Contact 1 > 0, Change of State, Low Limit, High Limit, Fire, Runtime, and Supervisory.

In the normal condition (**AS**=0), there are no alarms for the associated input.

AS="Contact 1 > 0" indicates that the input is in an alarm condition because **AE**=1 and a transition from 0 to 1 has been detected on the input.

Similarly, **AS**="Contact 0 > 1", indicates that the input is in an alarm condition because **AE**=2 and a transition from 1 to 0 has been detected.

If **AS**="Change of State", it indicates that a transition has occurred on the input. When **AE** is set to "Change of State", the **CV** of the input is taken as the normal state. When the state of the input changes to the opposite state, an alarm will be generated and, when the value returns to the normal state for that input, an alarm return will be generated.

AS=5 indicates that the input is in a low limit alarm state. This will occur when **CV** drops below **LL** and **AE**=4 or **AE**=7.

Similarly, when **AS**=6, a high limit alarm is indicated. This is a result of **CV** exceeding **HL** while **AE**=5 or **AE**=6.

A fire condition is indicated when **AS**=8. This will occur when the corresponding input, configured as a digital input and set for fire detection, indicates a value of 1 and **AE**=8.

If **AS**=10, it indicates a run-limit alarm. This is the case when the run hours (**RH**) exceeds the run limit (**RL**).

Finally, if **AS**=11 through **AS**=22, the input is in a supervisory alarm state. This indicates that the controller has changed the state for the digital output that this input is supervising but the input has not detected a changed state after an amount of time specified by **AD**.

Attribute **AE** is the alarm function attribute. **AE** enables the various types of alarming for the associated input. This attribute can specify one of 20 alarming types to be used. The alarming options are Disabled, Contact 0 > 1, Contact 1 > 0, Change of State, Low Limit, High Limit, Low & High Limit, Fire, and Supervise DO1 through DO12.

If **AE**="Disabled", then alarming has been disabled for the corresponding input channel and no alarms will be generated.

When **AE**="Contact 0 > 1", an input configured as a digital input will generate an alarm when its value transitions from 0 to 1. Similarly **AE**="Contact 1 > 0" will generate an alarm for a digital input that transitions from 1 to 0.

For **AE**="Change of State", the **CV** of the input when the option is set is taken as the normal state. When the **CV** of the input changes to the opposite state, an alarm will be generated. When the value returns to the normal state, an alarm return will be generated. For example, if an input is configured for change of state alarming and it has a **CV** of 0, then that state will be normal for the input. If **CV** changes to a value of 1, then a change of state alarm will be generated. When **CV** returns to 0, an alarm return would be generated. If **CV** had been 1 when **AE** was set, then the alarm would be generated on the transition to a 0 and a return would be sent when it returned to a 1.

WARNING
When power is cycled to the controller, the normal state for an input configured for Change of State alarming will be set to the CV of the input.

Low limit alarming (**AE**="Low Limit") will generate an alarm when the **CV** of the analog input drops below the low alarm limit (**LL**). Similarly, high limit alarming (**AE**="High Limit") will generate an alarm if the current value of the analog input exceeds the high alarm limit (**HL**). If **AE**="Low & High Limit", an alarm will be generated if **CV** drops below the low alarm limit (**LL**) or exceeds the high alarm limit (**HL**).

When configured for fire alarming (**AE**="Fire"), an alarm will be generated if a digital input configured for fire detection indicates a value of 1. By adjusting the input polarity (**IP**), the fire alarming can be configured to operate so that the fire alarm state (**CV**=1) will occur either when the signal is open (**IP**=0) or closed (**IP**=1). This is to accommodate different kinds of fire sensors.

For **AE**="Supervise DO1" through **AE**="Supervise DO12", the SBC-GPC3 will supervise DO1 through DO12 respectively. When supervising an output, the controller will wait an amount of time specified in **AD** and then compare the supervisory input state to that of the output. If they do not match, a supervisory alarm will be generated.

For all types of alarming on analog inputs, there is an alarm delay attribute (**AD**).

Attribute **AD** specifies an alarm delay which can be used when monitoring the effects of the corresponding digital outputs. A supervisory alarm is generated when a digital input fails to make a transition when the corresponding outputs makes a transition. **AD** specifies a delay time in seconds (0-6000) that must elapse after the output changes state before the corresponding digital input is checked for supervision.

Attribute **SU** specifies the amount to setup/setback the alarm setpoints. **SU** is a value (0.0 to 25.5) which is added to **HL** and subtracted from **LL** during scheduled unoccupied periods.

Attribute **SM** is the schedule bitmap. By setting one or more of the bits in **SM** to 1, you can enable schedule control on the associated input. When all of the active schedules in **SM** enter an unoccupied mode, the high- and low-alarms limits will be setup/setback by an amount **SU**. Each bit of **SM** and its corresponding schedule are given in Table 3-8.

Table 3-8 : Schedules to Follow

0	F901
1	F902
2	F903
3	F904
4	F905
5	F906

Table 3-8 : Schedules to Follow

6	F907
7	F908
8	SMARTStat 1
9	SMARTStat 2
10	SMARTStat 3
11	SMARTStat 4
12	SMARTStat 5
13	SMARTStat 6
14	SMARTStat 7
15	SMARTStat 8
16	SMARTStat 9
17	SMARTStat 10
18	SMARTStat 11
19	SMARTStat 12
20	Host Schedule
21	F900
22	FC01

Bits #0-7 of **SM** are used to enable Schedule channels 1-8 respectively on the input.

Bits #0-7 of **SM** are used to enable Schedule channels 1-8 respectively on the input.

Bits #8-19 enable SmartStat overrides. When the controller is in unoccupied mode and the SBC-GPC1 detects that a button on the associated SmartStat has been pressed, it will switch to occupied mode for an amount of time specified by FE00;**ED**.

Bit #20 is used to enable host schedule override for the corresponding channel. When this bit is selected, if the host schedule is enabled (**HE**=1) and the host schedule status (**HO**) indicates unoccupied mode, then the alarm limits will be setup/setback.

Bit #21 is used to command the input to follow the current schedule value observed by the Main Schedule Summary Channel (F900;CV).

Bit #22 is used to command the input to follow the current host override value observed by the Occupancy Detector Channel (FC01;CV)

Attribute **IF** specifies an input filter delay. **IF** is the debounce time (in seconds) during which a digital input must remain stable to avoid the signal being read as a digital bounce. In the case of a bounce, the channel reliability, **RE**, is set to 1. For analog inputs, **IF** specifies a weighted gain used to smooth the values from a fluctuating input.

Attribute **IP** is the input polarity bitmap for digital inputs on the SBC-GPC3. Setting the bits of **IP** specifies how the controller represents the input internally. A value of **IP**=0 indicates normal polarity. In this case

low voltage is displayed as **CV**=0 and high voltage is displayed as **CV**=1. If **IP**=1, the input is configured to operate using reverse polarity. Here, low voltage is displayed as **CV**=1 and high voltage is displayed as **CV**=0.

Attributes **RH** and **RL** are used for runtime monitoring and alarming. **RH** indicates the number of hours **CV**=1 for the associated digital input. **RL** is the run limit for the input. If **RH** exceeds **RL**, then a run limit alarm will be generated. Setting **RL**=0.0 disabled run limit alarms for the input.

Attribute **OI** allows you to override the value of the channel's input **CV**. If **OI** is set to 0, overriding is disabled, and you will read the value of the wired input. If you set **OI** to 1, you can manually change the value of the input with a user interface device. To override an input value, you must set **OI**=1 and then change **CV** to the desired override value. Analog input overrides can also be accomplished from the Analog Input Summary channel (FE00) using the **OI** bitmap and either input values **V1** through **VO** or the appropriate **CV**.

Attribute **OF** is an input offset. **OF** specifies an offset amount to be added to the current value. This can be used to correct the readings of sensors whose readings differ from the actual value by a fixed amount.

Attribute **ED** is the Extended Occupancy Duration for UIs mapped to STAT devices. This attribute shows the amount of time in minutes to extend override occupancy.

Attribute **ER** is the Extended Occupancy Time Remaining for UIs mapped to STAT devices. This attribute shows the amount of time in minutes that is remaining for a current override occupancy.

Attribute **GI** indicates the global identification number of the STATbus device associated with the universal input. **GI** is used to assign a remote I/O device to the channel when the **GP** is set to edit more (FF00;**CR**=2). If the inputs does not have a STATbus device mapped to it, **GI** will be zero.

Universal Inputs 1-24, FE01-FE18

Attribute	Description
ON	Universal Input Name specifies a user definable string that is used to help identify the channel or its function.
CV	Current Measured Input Value displays the scaled value of the associated universal input.
RE	Data Reliability indicates whether the reading from the input is considered reliable. 0=Reliable 1=Unreliable
ST	Sensor Type specifies the type of sensor connected to the input. 0=Digital 2=MN..MX 0 to 5V 3=MN..MX 4 to 20mA 4=Curve 1 5=Curve 2 6=MN..MX 0 to 10V 7=Thermistor -30.0 to 230.0 8=MN..MX 0 to 20mA 9=SMARTStat Temperature 10=SMARTStat Humidity
DT	PUP Datatype for Input specifies the PUP datatype for the input.
DF	Display Format specifies the way in which the stat will display the temperature. 0=##d 1=##.#d 2=##dF 3=##.#dF
TM	Thermostat Multiplier specifies the magnitude of the user setpoint offset. Each press of the up or down buttons on a stat will increment the setpoint by an amount TM . There are five steps above and below the setpoint, providing for a maximum offset amount of 5x TM above or below the setpoint.
MN	Minimum Scaled Value specifies the minimum scaled value in engineering units.
MX	Maximum Scaled Value specifies the maximum scaled value in engineering units.
LL	Low Alarm Limit if alarming is enabled and the current value, CV , drops below LL , then a low limit alarm will be generated.
HL	High Alarm Limit if alarming is enabled and the current value, CV , rises above HL , then a high limit alarm will be generated.

Attribute	Description
HS	Alarm Limit Hysteresis specifies a value that determines when the controller returns from a high- or low-alarm limit. The current value, CV , must be HS below HL or HS above LL before a limit return is generated.
AS	Alarm Status indicates the alarm state for the input. 0=Normal 1=Contact 0>1 2=Contact 1>0 3=Change of State 5=Low Limit 6=High Limit 8=Fire 10=Runtime 11=Supervisory
AE	Alarm Enable specifies the type of alarming to be used by the input. 0=Disabled 1=Contact 0>1 2=Contact 1>0 3=Change of State 4=Low Limit 5=High Limit 6=Low & Hi Limit 8=Fire 11=Supervise DO1 12=Supervise DO2 13=Supervise DO3 14=Supervise DO4 15=Supervise DO5 16=Supervise DO6 17=Supervise DO7 18=Supervise DO8 19=Supervise DO9 20=Supervise DO10 21=Supervise DO11 22=Supervise DO12
AD	Alarm Delay specifies the amount of time that the input must exceed a limit before an alarm condition is generated. 0=Disable 1-6000 Seconds
SU	Amount to Setup/Setback Alarm Limit specifies a value (0.0 to 25.5) which is added to HL and subtracted from LL during scheduled unoccupied periods.

Attribute	Description
SM	<p>Schedules to Follow enables scheduled alarm controlling for the associated universal input by selecting one or more of the available schedule control channels.</p> <p>0=Schedule disabled 1=Schedule enabled</p> <p>SM is a bitmap with bit #0=F901 bit #1=F902 bit #2=F903 bit #3=F904 bit #4=F905 bit #5=F906 bit #6=F907 bit #7=F908 bit #8=SMARTStat1 bit #9=SMARTStat2 bit #10=SMARTStat3 bit #11=SMARTStat4 bit #12=SMARTStat5 bit #13=SMARTStat6 bit #14=SMARTStat7 bit #15=SMARTStat8 bit #16=SMARTStat9 bit #17=SMARTStat10 bit #18=SMARTStat11 bit #19=SMARTStat12 bit #20=Host Schedule bit #21=F900 bit #22=FC01</p>
IF	<p>Input Filter Delay or Weighted Gain the debounce time (in seconds) during which the input must remain stable to avoid the signal being read as a digital bounce. In the case of a bounce, the channel reliability, RE, is set to 1.</p> <p>For analog inputs, IF specifies a weighted gain used to smooth the values from a fluctuating input.</p>
IP	<p>Input Polarity specifies how the controller represents the input internally.</p> <p>0=Normal Polarity. Low Voltage is displayed as CV=0 and High Voltage is displayed as CV=1. 1=Reverse Polarity. Low Voltage is displayed as CV=1 and High Voltage is displayed as CV=0.</p>
RH	<p>Run Hours indicates the number of hours CV=1 for the input.</p>
RL	<p>Run Limit specifies a number of hours that CV=1 after which a run limit alarm is generated. Setting RL=0.0 disabled run limit alarms for the input.</p>
OI	<p>Override Input? allows the current value of the input, CV, to be overridden.</p> <p>0=No 1=Yes</p>
OF	<p>Input Offset specifies an offset amount to be added to the current value.</p>

Attribute	Description
ED	<p>Extended Occupancy Duration specifies the amount of time in minutes to extend override occupancy.</p>
ER	<p>Extended Occupancy Duration Remaining specifies the amount of time remaining in extended override occupancy.</p>
GI	<p>GID of I/O Device indicated the global identification number of the STATbus device associated with the universal input. If the inputs does not have a STATbus device mapped to it, GI will be 0.</p>

3.5 DIGITAL INPUT SUMMARY, FE30

The Digital Input Summary channel is a convenient way to monitor the states and many of the options for the digital inputs on the SBC-GPC3. From this channel, you can check the current values (**CV**) as well as the channel reliabilities (**RE**) for each digital input. This channel will also display any inputs that are currently overridden (**OI**). The input polarities (**IP**) as well as the interlock polarities (**LP**) for each channel will also be displayed. The Digital Input Summary channel has the following attributes: **ON**, **CV**, **OI**, **RE**, **LP**, and **IP**.

Attribute **ON** stores the name of the channel. This is a user definable string that can be used to help identify the channel.

Attribute **CV** indicates the current value of the associated Digital input. **CV** is a bitmap with bit #0 corresponding to FE31, bit #1=FE32, etc. up to bit #7=FE38.

Attribute **OI** allows you to override the value of the channel's input **CV**. **OI** is a bitmap with bit #0 corresponding to FE31, bit #1=FE32, etc. up to bit #7=FE38. If **OI** is set to 0, overriding is disabled, and you will read the value of the wired input. If you set **OI** to 1, you can manually change the value of the input with a user interface device. To override an input value, you must set **OI**=1 and then change **CV** to the desired override value.

Attribute **RE** displays the channel reliability. **RE** indicates whether a an input is questionable. In the case of a digital input, the reliability will be 1 during the time when the input filter delay (**IF**) elapses. **RE** is a bitmap with bit #0 corresponding to FE31, bit #1=FE32, etc. up to bit #7=FE38. A value of 0 indicates that the input is reliable while a value of 1 means that the input associated with that bit is unreliable.

Attribute **LP** displays the interlock polarities. Each bit of **LP** indicates the individual interlock polarity states for the corresponding digital input. For normal operation (**LP**=0), the corresponding input is considered to be normal when **CV**=0. When the corresponding bit is configured for reverse operation (**LP**=1), then the input will be considered normal when **CV**=1.

Attribute **IP** displays the input polarities. Each bit of **IP** specifies how the controller internally represents the corresponding digital input. When an input is set to normal polarity (**IP**=0), low voltage is displayed as **CV**=0 and high voltage is displayed as **CV**=1. If, however, the polarity is set to reverse polarity (**IP**=1), then low voltage will be displayed as **CV**=1 and high voltage as **CV**=0.

Digital Input Summary, FE30

Attribute	Description
ON	Digital Inputs Summary Name specifies a user definable string that is used to help identify the channel or its function.
CV	Current Digital Input Value indicates the current state of the associated digital input. bit #0=FE31 bit #1=FE32 bit #2=FE33 bit #3=FE34 bit #4=FE35 bit #5=FE36 bit #6=FE37 bit #7=FE38
OI	Overridden Inputs indicates any inputs which have been overridden. bit #0=FE31 bit #1=FE32 bit #2=FE33 bit #3=FE34 bit #4=FE35 bit #5=FE36 bit #6=FE37 bit #7=FE38
RE	Inputs with Unreliable Values indicates whether the reading from the corresponding digital input is considered reliable. 0=Reliable 1=Unreliable bit #0=FE31 bit #1=FE32 bit #2=FE33 bit #3=FE34 bit #4=FE35 bit #5=FE36 bit #6=FE37 bit #7=FE38
IP	Input Polarities specifies how the controller represents the input internally. 0=Normal polarity. Low Voltage is displayed as present_value=0 and High Voltage is displayed as present_value=1 . 1=Reverse polarity. Low Voltage is displayed as present_value=1 and High Voltage is displayed as present_value=0 . bit #0=FE31 bit #1=FE32 bit #2=FE33 bit #3=FE34 bit #4=FE35 bit #5=FE36 bit #6=FE37 bit #7=FE38

Attribute	Description
LP	Interlock Polarities indicates the individual interlock polarity states for each Digital Input. 0=Normal 1=Reverse bit #0=FE31 bit #1=FE32 bit #2=FE33 bit #3=FE34 bit #4=FE35 bit #5=FE36 bit #6=FE37 bit #7=FE38

3.6 DIGITAL INPUT, FE31-FE38

Digital inputs are special inputs that operate at a higher frequency than a Universal Input configured to read a digital signal. This makes it possible to not only detect an on or off signal but also count the number of transitions from one state to the other. Each Digital Input channel has the following attributes: **ON**, **CV**, **DT**, **RE**, **AS**, **AE**, **AD**, **IF**, **IP**, **RH**, **RL**, **OI**, **NP**, **MD**, **SF**, **SV**, and **GI**.

Attribute **ON** stores the name of the channel. This is a user definable string that can be used to help identify the channel or, for example, the type of sensor connected to the input or the sensor's location.

Attribute **CV** indicates the current value of the associated digital input.

Attribute **DT** determines how certain attributes will display their values. The default value for **DT** is 254 (unsigned 10 digit).

Attribute **RE** displays the channel reliability. **RE** indicates whether an input is questionable. In the case of a digital input, the reliability will be 1 during the time when the input filter delay (**IF**) elapses.

Attributes **AS**, **AE**, **AD**, **IF**, **RH**, and **RL** are used to configure the alarming options for the digital input.

The alarm status attribute, **AS**, defines the current alarm state for the corresponding input. The possible values for **AS** are Normal, Contact 0 > 1, Contact 1 > 0, Change of State, Fire, Runtime, and Supervisory.

In the normal condition, **AS**="Normal", there are no alarms for the associated input.

If **AS**="Contact 0 > 1", it indicates that the input is in an alarm condition. This will occur if **AE**="Contact 0 > 1" and a transition from 0 to 1 has been detected.

Similarly, **AS**="Contact 1 > 0", indicates that the input is in an alarm condition. This will occur if **AE**="Contact 1 > 0" and a transition from 1 to 0 has been detected.

If **AS**="Change of State", it indicates that a transition has occurred on the input. When **AE** is set to "Change of State", the **CV** of the input is taken as the normal state. When the state of the input changes to the opposite state, an alarm will be generated and, when the value returns to the normal state for that input, an alarm return will be generated.

A fire condition is indicated when **AS**="Fire". This will occur when the corresponding input, indicates a value of 1 and **AE**="Fire".

If **AS**="Runtime", it indicates a run-limit alarm. This is the case when the run hours (**RH**) exceeds the run limit (**RL**).

Finally, if **AS**=11, the input is in a supervisory alarm state. This indicates that the controller has detected a change of state for the digital output but the associated digital input in the corresponding channel has not changed state after an amount of time specified by **SD**.

Attribute **AE** is the alarm function attribute. **AE** enables the various types of alarming for the associated input. This attribute can specify one of 17 alarming types to be used. The alarming options are Disabled, Contact 0 > 1, Contact 1 > 0, Change of State, Fire, and Supervise DO1 through DO12.

If **AE**="Disabled", then alarming has been disabled for the corresponding input channel.

When **AE**="Contact 0 > 1", the digital input will generate an alarm when its value transitions from 0 to 1. Similarly **AE**="Contact 1 > 0" will generate an alarm for a digital input that transitions from 1 to 0.

For **AE**="Change of State", the **CV** of the input when the option is set is taken as the normal state. When the **CV** of the input changes to the opposite state, an alarm will be generated. When the value returns to the normal state, an alarm return will be generated. For example, if an input is configured for change of state alarming and it has a **CV** of 0, then that state will be normal for the input. If **CV** changes to a value of 1, then a change of state alarm will be generated. When **CV** returns to 0, an alarm return would be generated. If **CV** had been 1 when **AE** was set, then the alarm would be generated on the transition to a 0 and a return would be sent when it returned to a 1.

WARNING

When power is cycled to the controller, the normal state for an input configured for Change of State alarming will be set to the **CV** of the input.

When configured for fire alarming (**AE**="Fire"), an alarm will be generated if a digital input configured for fire detection indicates a value of 1. By adjusting the input polarity (**IP**), the fire alarming can be configured to operate so that the fire alarm state (**CV**=1) will occur either when the signal is open (**IP**=0) or closed (**IP**=1). This is to accommodate different kinds of fire sensors.

For **AE**="Supervise DO1" through **AE**="Supervise DO12", the SBC-GPC3 will supervise DO1 through DO12 respectively. When supervising an output, the controller will wait an amount of time specified in **AD** and then compare the supervisory input state to that of the output. If they do not match, a supervisory alarm will be generated.

For all types of alarming, there is an alarm delay attribute (**AD**) which specifies the amount of time, in seconds, that the input must stay in an alarm state before an alarm condition is actually generated. This delay can be any value between 1 and 6000 seconds. Setting **AD**=0 will disable the alarm delay. **AD** is used to compensate for noisy signal that may fluctuate in and out of a state that would cause an alarm to be generated.

Attribute **IF** specifies an input filter delay. **IF** is the debounce time (in seconds) during which a digital input must remain stable to avoid the signal being read as a digital bounce. In the case of a bounce, the channel reliability, **RE**, is set to 1.

Attribute **IP** displays the input polarity of the associated digital input. **IP** specifies how the controller internally represents the input. When an input is set to normal polarity (**IP**=0), low voltage is displayed as **CV**=0 and high voltage is displayed as **CV**=1. If, however, the polarity is set to reverse polarity (**IP**=1), then low voltage will be displayed as **CV**=1 and high voltage as **CV**=0.

Attributes **RH** and **RL** are used for runtime monitoring and alarming. **RH** indicates the number of hours **CV**=1 for the associated digital input. **RL** is the run limit for the input. If **RH** exceeds **RL**, then a run limit alarm will be generated. Setting **RL**=0.0 disabled run limit alarms for the input.

Attribute **OI** allows you to override the value of the channel's input **CV**. If **OI** is set to 0, overriding is disabled, and you will read the value of the wired input. If you set **OI** to 1, you can manually change the value of the input with a user interface device. To override an input value, you must set **OI**=1 and then change **CV** to the desired override value.

Attributes **NP**, **MD**, **SF**, and **SV** are used when the digital input is enabled for pulse counting.

Attribute **NP** stores the raw number of pulses that have been detected by the controller. This value may be converted to a scaled pulse count (**SV**) by multiplying the value of **NP** by a pulse multiplier (**SF**).

Attribute **MD** is the pulse counter mode and defines how the SBC-GPC3 will detect a pulse. There are two ways that a pulse can be detected, by sensing the rising edge of the pulse (**MD**="Rising Edge"), by sensing the falling edge of the pulse (**MD**="Falling Edge"), or both (**MD**="Both"). The differences between the rising edge and falling edge of the pulse are shown in Figure 3-2.

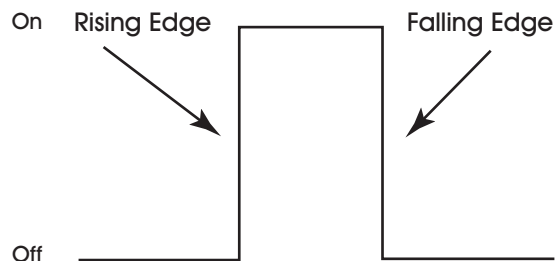

Figure 3-2: Rising and Falling Edges of a Pulse

Setting **MD**="Disabled" will disable the pulse counting features for the digital input.

Attribute **SF** specifies a scaling factor that is multiplied by **NP** to obtain a scaled count (**SV**). The final scaled pulse count, **SV**, is found using the formula $SV = NP \times SF$. Both **SF** and **SV** are single-precision, floating point values.

Attribute **GI** is the GID of a STATbus device with a digital input associated with it. When a STATbus device is used as an digital input, the global identification number of that device will be set using in **GI**. If no STATbus device is being used, **GI** will display a value of zero.

Digital Inputs 1-4, FE31-FE34

Attribute	Description
ON	Digital Input Name specifies a user definable string that is used to help identify the channel or its function.
CV	Current Input Value indicates the current state of the associated digital input.
DT	PUP Datatype for Input specifies the PUP datatype for the input.
RE	Data Reliability indicates whether the reading from the corresponding digital input is considered reliable. 0=Reliable 1=Unreliable
AS	Alarm Status indicates the alarm state for the input. 0=Normal 1=Contact 0>1 2=Contact 1>0 3=Change of state 8=Fire 10=Runtime 11=Supervisory
AE	Alarm Enable specifies the type of alarming to be used by the input. 0=Disabled 1=Contact 0>1 2=Contact 1>0 3=Change Of State 8=Fire 11=Supervise DO1 12=Supervise DO2 13=Supervise DO3 14=Supervise DO4 15=Supervise DO5 16=Supervise DO6 17=Supervise DO7 18=Supervise DO8 19=Supervise DO9 20=Supervise DO10 21=Supervise DO11 22=Supervise DO12
AD	Alarm Delay specifies the amount of time that the input must exceed a limit before an alarm condition is generated. 0=Disable 1-6000 seconds
IF	Input Filter Delay the debounce time (in seconds) during which the input must remain stable to avoid the signal being read as a digital bounce. In the case of a bounce, the channel reliability, RE , is set to 1.

Attribute	Description
IP	Input Polarity specifies how the controller represents the input internally. 0=Normal polarity. Low Voltage is displayed as CV=0 and High Voltage is displayed as CV=1 . 1=Reverse polarity. Low Voltage is displayed as CV=1 and High Voltage is displayed as CV=0 .
RH	Run Hours indicates the number of hours CV=1 for the input.
RL	Run Limit specifies a number of hours that CV=1 after which a run limit alarm is generated. Setting RL=0.0 disabled run limit alarms for the input.
OI	Override Input? allows the current value of the input, CV , to be overridden. 0=No 1=Yes
NP	Number of Pulses Accumulated displays the current number of pulses detected on the digital input.
MD	Pulse Counter Mode defines how the GPC detects a pulse. 0=Rising edge 1=Falling edge 2=Both 3=Disable
SF	Pulse Multiplier specifies a scaling factor that is multiplied by NP to obtain a scaled count.
SV	Scaled Pulse Count displays a scaled version of NP using the formula SV = NP x SF
GI	GID of I/O Device indicated the global identification number of the STATbus device associated with the output. If the inputs does not have a STATbus device mapped to it, GI will be 0.

3.7 OCCUPANCY DETECTOR, FC01

The Occupancy Detector channel allow you to define the circumstances under which the SBC-GPC3 will switch to an extended occupied mode during unoccupied periods when an occupancy detector is used with the controller. The Occupancy Detector channel has the following attributes: **ON**, **MS**, **MT**, **IC**, **IA**, **MD**, and **MR**.

Attribute **MS** is Occupancy Detector Input Status. This read-only attribute shows the status of the occupancy detector input.

Attribute **MT** is Extended Occupancy Duration. It defines, in minutes, the length of time to override the zone whenever occupancy is detected.

Attributes **IC** and **IA** specify the channel and attribute to be used for Occupancy Detection.

NOTE

To clear **IC** and remove the association with its target channel, you must write a value of 0000 (four zeroes) to **IC**.

To enable occupancy detection, **MT** must be greater than 0 and the occupancy detector input specified in **IC** and **IA** must be configured as a digital input. If either of these two conditions are not met, **MS** will display 0. When occupancy in the zone is detected, i.e. the input specified by **IC** and **IA** has a value of 1, during unoccupied periods, the occupancy input extends occupancy time by the amount specified in **MT**.

Attribute **MD** is Extended Occupancy Delay. It sets the amount of time, in seconds, during which the occupancy detector must remain on before the occupancy detector will override the zone. This prevents false triggers that might occur as others pass quickly through the zone.

Attribute **MR** is Extended Occupancy Remaining. This read-only point displays the time remaining before the controller returns to unoccupied mode.

Occupancy Detector, FC01

Attribute	Description
ON	Occupancy Output Name specifies a user definable string that is used to help identify the channel or its function.
MS	Occupancy Status indicates whether the channel and attribute specified in IC and IA indicate that the monitored zone is occupied.
MT	Extended Occupancy Duration specifies the time, in minutes, that the controller will stay in occupied mode once occupancy is detected.
IC	Input Channel for Occupancy Duration specifies the channel of the input to be used for occupancy detection.
IA	Input Attribute for Occupancy Duration specifies the attribute associated with the channel specified in IC to be used for occupancy detection.
MD	Extended Occupancy Delay specifies the time, in minutes, that the occupancy detector status, MS , must be positive before the controller will switch to occupied mode.
MR	Extended Occupancy Remaining indicates the time, in minutes, before the controller reverts to unoccupied mode.

3.8 ANALOG OUTPUT SUMMARY, FD00

The Analog Output Summary channel is a convenient way to monitor the states and many of the options for the analog outputs on the SBC-GPC3. From this channel, you can check the current values (**V1-VC**) for each output. This channel also allows you to set whether the output will be controlled automatically or manually (**AM**) as well as determine the output's behavior in the case of a communications failure (**CF**). The Analog Output summary channel has the following attributes: **ON, V1, V2, V3, V4, V5, V6, V7, V8, V9, VA, VB, VC, RE, AM,** and **CF**.

Attribute **ON** stores the name of the channel. This is a user definable string that can be used to help identify the channel.

Attribute **V1** through **VC** display the current values for analog outputs 1 through 12 respectively.

Attribute **RE** indicates channel reliability for the analog outputs. The reliability is only used for outputs on the STATbus. When a control sequence within the SBC-GPC3 changes the value of an output, the SBC-GPC3 sends a command out over the STATbus network telling the output device to change its value. If the message to change its value is successfully received, then the STATbus device will send a message back to the SBC-GPC3 acknowledging the request. If the SBC-GPC3 sends such a message, but does not receive an acknowledgement, then the controller will flag the output as unreliable. If an output is unreliable, the SBC-GPC3 will set the corresponding bit in **RE** to 1. A value of zero indicates that the output is reliable.

Attribute **AM** determines which outputs will operate in automatic mode. **AM** is a bitmap with bit 0 corresponding to FD01, bit 1=FD02, etc. up to bit 11=FD0C. If the corresponding bit in **AM** is set equal to 1, then the corresponding output is being controller automatically by the SBC-GPC3. If a bit in **AM** is set equal to 0, then the corresponding output is being controlled manually, either by a host controller or an SPL program.

Attribute **CF** is the communications failure enable/disable attribute. This attribute enables the communications failure feature on an individual basis for each analog output channel of the SBC-GPC3. If the analog output channel is in manual mode (**AM=0**), communications with the host is lost (bit #6 of FF00;**FA=1**), and **CF** is enabled by setting **CF=1**, then the current output value (**CV**) reverts to the programmed failure position (**FP**) for the corresponding output.

Analog Output Summary, FD00

Attribute	Description
ON	Analog Output Summary Name specifies a user definable string that is used to help identify the channel or its function.
V1	Current Value for Output 1 indicates the current value of output 1.
V2	Current Value for Output 2 indicates the current value of output 2.
V3	Current Value for Output 3 indicates the current value of output 3.
V4	Current Value for Output 4 indicates the current value of output 4.
V5	Current Value for Output 5 indicates the current value of output 5.
V6	Current Value for Output 6 indicates the current value of output 6.
V7	Current Value for Output 7 indicates the current value of output 7.
V8	Current Value for Output 8 indicates the current value of output 8.
V9	Current Value for Output 9 indicates the current value of output 9.
VA	Current Value for Output 10 indicates the current value of output 10.
VB	Current Value for Output 11 indicates the current value of output 11.
VC	Current Value for Output 12 indicates the current value of output 12.
RE	Outputs with Unreliable States indicates whether the reading from the corresponding analog output is considered reliable. 0=Reliable 1=Unreliable bit #0=FD01 bit #1=FD02 bit #2=FD03 bit #3=FD04 bit #4=FD05 bit #5=FD06 bit #6=FD07 bit #7=FD08 bit #8=FD09 bit #9=FD0A bit #10=FD0B bit #11=FD0C

Attribute	Description
AM	Outputs in Automatic Mode specifies how the analog output is controlled. 0=Manual 1=Automatic bit #0=FD01 bit #1=FD02 bit #2=FD03 bit #3=FD04 bit #4=FD05 bit #5=FD06 bit #6=FD07 bit #7=FD08 bit #8=FD09 bit #9=FD0A bit #10=FD0B bit #11=FD0C
CF	Outputs Enabled for Communication Failure enables the communications failure feature on an individual basis for each analog output. 0=Disabled 1=Enabled bit #0=FD01 bit #1=FD02 bit #2=FD03 bit #3=FD04 bit #4=FD05 bit #5=FD06 bit #6=FD07 bit #7=FD08 bit #8=FD09 bit #9=FD0A bit #10=FD0B bit #11=FD0C

3.9 ANALOG OUTPUTS 1-12, FD01-FD0C

The Analog Output channels on the SBC-GPC3 allow the user to configure the options for each analog output. The user can set minimum and maximum values, both in engineering units (**MN** and **MX**) as well as scaled values (**LS** and **HS**). The user can also set up various alarming options for the analog output. Each Analog Output channel has the following attributes: **ON**, **CV**, **RE**, **DT**, **MN**, **MX**, **LS**, **HS**, **AM**, **IL**, **CF**, **FP**, **UT**, **FI**, **OU**, and **GI**.

Attribute **ON** stores the name of the channel. This is a user definable string that can be used to help identify the channel or, for example, the type of output connected.

Attribute **CV** indicates the current value of the associated analog output. The current value of the output can be manually controlled by a user manually writing a value to **CV**, controlled by a host controller writing a value to **CV**, or controlled automatically by the SBC-GPC3.

Attribute **RE** indicates channel reliability for the analog outputs. The reliability is only used for outputs on the STATbus. When the a control sequence within the SBC-GPC3 changes the value of an output, the SBC-GPC3 sends a command out over the STATbus network telling the output device to change its value. If the message to change its value is successfully received, then the STATbus device will send a message back to the SBC-GPC3 acknowledging the request. If the SBC-GPC3 sends such a message, but does not receive an acknowledgement, then the controller will flag the output as unreliable. If an output is unreliable, the SBC-GPC3 will set **RE** to 1. A value of zero indicates that the output is reliable.

Attribute **DT** indicates the datatype for the current value of the associated output. **DT** determines how **CV**, **MN**, and **MX** will be displayed.

Attributes **MN** and **MX** are the minimum and maximum engineering units attributes. These attributes define the range of **CV** that is displayed by the SBC-GPC3. The output's value may be scaled to units that are more meaningful in the control application being used (e.g., percent, psi, voltage, current, etc.). The minimum and maximum values of the range can be set in attributes **MN** and **MX**. Reverse scaling can be accomplished by setting **MN** > **MX**. **MN** and **MX** default to 0.0 and 100.0, respectively.

Attributes **LS** and **HS** are the low and high scaled voltage attributes. These attributes specify a range of the total output signal that is then scaled across **MN** and **MX**. Reverse scaling can be accomplished by setting **LS** > **HS**. **LS** and **HS** default to 0.0% and 100.0%, respectively.

For example, if the analog output value (**CV**) is to be displayed as a percentage (0-100) of a 10 VDC output range, set **MN** to 0 and **MX** to 100 (a 0.0%-100.0% display range). Set **LS**=0.0% and **HS**=100.0% (the full range of the output signal), because **CV**=0 represents 0.0% of the output range and **CV**=100 represents 100.0% of the output range.

Attribute **AM** determines whether the associated output will operate in automatic or manual mode. If **AM** is set equal to 1, then the output is being controller automatically by the SBC-GPC3. If **AM** is set equal to 0, then the output is being controlled manually, either by a host controller or an SPL program.

Attribute **IL** is the interlock bitmap attribute. **IL** is used in conjunction with **FP** for interlocking of the analog output. Each bit (0-31) in the **IL** bitmap corresponds to a universal input or digital input of the SBC-GPC3. Any universal input configured to read a digital signal may be used for interlocking.

Attribute **CF** is the communications failure enable/disable attribute. This attribute enables the communications failure feature for the associated analog output channel of the SBC-GPC3. If a host or peer controller has an SPL program controlling the output, a communications failure occurs will cause the output to assume the position specified in **FP**.

When an output channel is in manual mode (**AM**=0), communications with the host is lost (bit #6 of **FF00;FA**=1), and **CF** is enabled by setting **CF**=1, then the current output value (**CV**) reverts to the programmed failure position (**FP**) for the corresponding output.

One or more of these inputs can be selected as interlocks by setting the corresponding bit in **IL** to 1. In the event that any of the digital inputs specified in **IL** has a value of 1, then the current value (**CV**) assumes its interlock failure position (**FP**). All of the inputs specified in **IL** must have a current value of 0 before normal control is restored to **CV**.

Attribute **FP** is the failure position attribute. **FP** specifies the current value (**CV**) that the output should take in the event an interlock or communications failure occurs. An interlock failure occurs when the value of any of the interlocks set in **IL** equals 1. For more information, refer to **IL**. A communications failure occurs when a host or peer controller has an SPL program controlling the SBC-GPC3's outputs and the communications timeout is exceeded.

Attribute **UT** specifies an update threshold for the current value. This is a threshold value by which **CV** must change before the output is updated.

Attribute **FI** is the fire position attribute. In the event of a fire condition (**FF00;FA** bit #0=1), the desired position (**DP**) reverts to the position specified in the fire position attribute (**FI**).

NOTE

If a communications failure or interlock failure occurs, then the desired position of the floating point control loop reverts to **FP**. If a fire condition then occurs while the communications or interlock failure is still active, **FI** takes priority over **FP**.

Attribute **OU** displays the actual state of each of the outputs. **OU** can differ from **CV** because it is possible for the actual output state to differ from the current value because of various delays.

Attribute **GI** is the GID of the STATbus device connected to the analog output. When a STATbus device is used as an analog output, the global identification number of that device will be displayed in **GI**. Otherwise, GI will display a value of zero.

Analog Outputs 1-12, FD01-FD0C

Attribute	Description
ON	Analog Output Name specifies a user definable string that is used to help identify the channel or its function.
CV	Current Output Value indicates the current value of the associated analog output.
RE	Data Reliability indicates whether the reading from the corresponding analog output is considered reliable. 0=Reliable 1=Unreliable
DT	PUP Datatype for Output specifies the PUP datatype for the output.
MN	Minimum Scaled Value specifies the minimum value for a scaled reading of CV , in Engineering Units.
MX	Maximum Scaled Value specifies the maximum value for a scaled reading of CV , in Engineering Units.
LS	Minimum Scaled Voltage specifies the percentage of the total output for CV=MN .
HS	Maximum Scaled Voltage specifies the percentage of the total output for CV=MX .
AM	Control Mode specifies how the analog output is controlled. 0=Manual 1=Automatic

Attribute	Description
IL	Inputs for Interlocking specifies which inputs (if any) are used as interlocks for the associated output (a value of 1 indicates that that input is used for interlocking). bit #0=FE01 bit #1=FE02 bit #2=FE03 bit #3=FE04 bit #4=FE05 bit #5=FE06 bit #6=FE07 bit #7=FE08 bit #8=FE09 bit #9=FE0A bit #10=FE0B bit #11=FE0C bit #12=FE0D bit #13=FE0E bit #14=FE0F bit #15=FE10 bit #16=FE11 bit #17=FE12 bit #18=FE13 bit #19=FE14 bit #20=FE15 bit #21=FE16 bit #22=FE17 bit #23=FE18 bit #24=FE31 bit #25=FE32 bit #26=FE33 bit #27=FE34 bit #28=FE35 bit #29=FE36 bit #30=FE37 bit #31=FE38
CF	Communication Failure Enable? 0=No 1=Yes
FP	Interlock/Comm Failure Position specifies the failure position (0-100%) for the output to be used in the event of an interlock or communications failure.
UT	Update Threshold specifies a threshold value by which CV must change before the output is updated.
FI	Fire Position specifies the failure position (0-100%) for the output to be used when a fire event is received.
OU	Actual Output Value indicates the actual output value of the analog output.
GI	GID of I/O Device indicated the global identification number of the STATbus device associated with the analog output. If the inputs does not have a STATbus device mapped to it, GI will be 0.

3.10 DIGITAL OUTPUT SUMMARY, FB00

The Digital Output Summary channel is a convenient way to monitor the states and many of the options for the digital outputs on the SBC-GPC3. From this channel, you can check the current values (**V1-VC**) for each output as well as the actual output state (**OU**). This channel also allows you to set whether the output will be controlled automatically or manually (**AM**) as well as determine the output's behavior in the case of a communications failure (**CF**). You can specify which outputs are to be enabled in the case of fire (**FE**) as well as set the output's fire state position (**FI**). The Digital Output Summary Channel has the following attributes: **ON**, **CV**, **AM**, **CF**, **FS**, **FI**, **FE**, **SB**, **RE**, **IS**, and **OU**.

Attribute **ON** stores the name of the channel. This is a user definable string that can be used to help identify the channel.

Attribute **CV** displays the current state (on or off) for each of the digital outputs. **CV** is a bitmap with bit #0 corresponding to BO1, bit #1=BO2, etc. up to bit #11=BO12. If a digital output is currently energized, then the corresponding bit in **CV** will be set equal to 1.

Attribute **AM** determines which outputs will operate in automatic mode. **AM** is a bitmap with bit #0 corresponding to BO1, bit #1=BO2, etc. up to bit #11=BO12. If the corresponding bit in **AM** is set equal to 1, then the corresponding output is being controlled automatically by the SBC-GPC3. If a bit in **AM** is set equal to 0, then the corresponding output is being controlled manually.

Attribute **CF** is the communications failure enable/disable attribute. This attribute enables the communications failure feature on an individual basis for each digital output channel of the SBC-GPC3. If the digital output is configured to operate in manual mode (**AM**=0), then the controller assumes the output states are being controlled by a host. If communications with the host are lost (bit #6 of FF00;**FA**=1), and **CF** is enabled by setting **CF**=1, then the current output value (**CV**) reverts to a programmed failure position (**FP**) for the corresponding output. **CF** is a bitmap with bit #0 corresponding to BO1, bit #1=BO2, etc. up to bit #11=BO12. Enabling a bit in **CF** will cause the corresponding output to assume the state defined in **FS** in the case of a communications failure.

Attribute **FS** defines the communication failure states for the digital outputs. **FS** functions in conjunction with **CF** and specifies the desired failure state for the corresponding input. **FS** is a bitmap with bit #0 corresponding to BO1, bit #1=BO2, etc. up to bit #11=BO12. The value of each bit in **FS** represents the desired failure state of the corresponding output (0=off, 1=on).

Attribute **FI** defines the fire states for the digital outputs. **FI** functions in conjunction with **FE** and specifies the desired failure state for the corresponding input. **FI** is a bitmap with bit #0 corresponding to BO1, bit #1=BO2, etc. up to bit #11=BO12. The value of each bit in **FI** represents the desired fire state of the corresponding output (0=off, 1=on).

Attribute **FE** specifies which outputs will be enabled in the event of a fire. **FE** is a bitmap with bit #0 corresponding to BO1, bit #1=BO2, etc. up to bit #11=BO12. If the SBC-GPC3 enters fire mode (FF00;**FA**=1), you may wish to turn certain outputs either on or off. Setting a bit in **FE** to 1 will cause the corresponding output to assume the state defines in **FI** when a fire event is detected. If **FE**=0 for a given bit, then the output will not take any action when a fire is detected.

Attribute **SB** defines which outputs are available for staging. **SB** is a bitmap with bit #0 corresponding to BO1, bit #1=BO2, etc. up to bit #11=BO12. If a bit in **SB** is set to 1, then the associated output is enabled for staging.

Attribute **RE** indicates channel reliability for the digital outputs. The reliability is only used for outputs on the STATbus. When the a control sequence within the SBC-GPC3 changes the value of an output, the

SBC-GPC3 sends a command out over the STATbus network telling the output device to change its value. If the message to change its value is successfully received, then the STATbus device will send a message back to the SBC-GPC3 acknowledging the request. If the SBC-GPC3 sends such a message, but does not receive an acknowledgement, then the controller will flag the output as unreliable. The channel reliability, **RE**, is a bitmap with bit 0 corresponding to BO1, bit 1=BO2, etc. up to bit 11=BO12. If an output is unreliable, the SBC-GPC3 will set the corresponding bit in **RE** to 1. A value of zero indicates that the output is reliable.

Attribute **IS** specifies the Inter-Stage ON Delay. This is the minimum time, in seconds (0-255), that must elapse after a staged output is energized before subsequent stages may be energized.

Attribute **OU** displays the actual state of each of the digital outputs. It is useful to have both because it is possible for the actual output state to differ from the current value because of various staging delays.

Digital Output Summary, FB00

Attribute	Description
ON	Digital Outputs Summary Name specifies a user definable string that is used to help identify the channel or its function.
CV	Digital Outputs which are On indicates which outputs are currently on. bit #0=BO1 bit #1=BO2 bit #2=BO3 bit #3=BO4 bit #4=BO5 bit #5=BO6 bit #6=BO7 bit #7=BO8 bit #8=BO9 bit #9=BO10 bit #10=BO11 bit #11=BO12
AM	Outputs in Automatic Mode specifies how the digital output is controlled. 0=Manual 1=Automatic bit #0=BO1 bit #1=BO2 bit #2=BO3 bit #3=BO4 bit #4=BO5 bit #5=BO6 bit #6=BO7 bit #7=BO8 bit #8=BO9 bit #9=BO10 bit #10=BO11 bit #11=BO12
CF	Outputs Enabled for Communication Fail specifies which outputs will be enabled in the event that a communication failure is detected. bit #0=BO1 bit #1=BO2 bit #2=BO3 bit #3=BO4 bit #4=BO5 bit #5=BO6 bit #6=BO7 bit #7=BO8 bit #8=BO9 bit #9=BO10 bit #10=BO11 bit #11=BO12

Attribute	Description
FS	Communication Failure Positions indicates which outputs are currently experiencing communications failures. bit #0=BO1 bit #1=BO2 bit #2=BO3 bit #3=BO4 bit #4=BO5 bit #5=BO6 bit #6=BO7 bit #7=BO8 bit #8=BO9 bit #9=BO10 bit #10=BO11 bit #11=BO12
FI	Fire Positions indicates which digital outputs are in fire mode. bit #0=BO1 bit #1=BO2 bit #2=BO3 bit #3=BO4 bit #4=BO5 bit #5=BO6 bit #6=BO7 bit #7=BO8 bit #8=BO9 bit #9=BO10 bit #10=BO11 bit #11=BO12
FE	Outputs Enabled for Fire specifies which outputs will be enabled in the event that a fire event is detected. bit #0=BO1 bit #1=BO2 bit #2=BO3 bit #3=BO4 bit #4=BO5 bit #5=BO6 bit #6=BO7 bit #7=BO8 bit #8=BO9 bit #9=BO10 bit #10=BO11 bit #11=BO12
SB	Outputs Enabled for Staging selects two or more digital outputs to be grouped together for staging. bit #0=BO1 bit #1=BO2 bit #2=BO3 bit #3=BO4 bit #4=BO5 bit #5=BO6 bit #6=BO7 bit #7=BO8 bit #8=BO9 bit #9=BO10 bit #10=BO11 bit #11=BO12

Attribute	Description
RE	<p>Outputs with Unreliable Values indicates whether the reading from the corresponding digital output is considered reliable.</p> <p>0=Reliable 1=Unreliable</p> <p>bit #0=BO1 bit #1=BO2 bit #2=BO3 bit #3=BO4 bit #4=BO5 bit #5=BO6 bit #6=BO7 bit #7=BO8 bit #8=BO9 bit #9=BO10 bit #10=BO11 bit #11=BO12</p>
IS	<p>Inter-Stage Delay specifies a minimum delay, in seconds (0-255) that must elapse after a staged output is energized before subsequent stages may be energized.</p>
OU	<p>Actual Output States indicates the actual output states of the digital outputs.</p> <p>bit #0=BO1 bit #1=BO2 bit #2=BO3 bit #3=BO4 bit #4=BO5 bit #5=BO6 bit #6=BO7 bit #7=BO8 bit #8=BO9 bit #9=BO10 bit #10=BO11 bit #11=BO12</p>

3.11 DIGITAL OUTPUTS 1-12, FB01-FB0C

The Digital Output channels on the SBC-GPC3 allow the user to configure the options for each digital output. The user can set minimum “on” and “off” times (**NT** and **FT**) as well as set up various alarming options for the digital output. Each Digital Output channel has the following attributes: **ON**, **CV**, **RE**, **NT**, **FT**, **PW**, **AM**, **AS**, **RH**, **RL**, **SM**, **SI**, **OU**, and **GI**.

Attribute **ON** stores the name of the channel. This is a user definable string that can be used to help identify the channel or, for example, to identify what the output is controlling.

Attribute **CV** is the *requested state* (0 or 1), rather than the *actual state* of the output (see attribute **OU**). In automatic mode (**AM**=1), **CV** is set through schedule control, thermostatic control, or floating point control. **CV** can be also set manually or via SPL program when the output is set for manual mode (**AM**=0). **CV** for each of the digital outputs can be viewed as a single bitmap from FB00;**CV**.

Attribute **RE** indicates channel reliability for the digital outputs. The reliability is only used for outputs on the STATbus. When the a control sequence within the SBC-GPC3 changes the value of an output, the SBC-GPC3 sends a command out over the STATbus network telling the output device to change its value. If the message to change its value is successfully received, then the STATbus device will send a message back to the SBC-GPC3 acknowledging the request. If the SBC-GPC3 sends such a message, but does not receive an acknowledgement, then the controller will flag the output as unreliable. The channel reliability, **RE**, is a bitmap with bit 1 corresponding to BO1, bit 2=BO2, etc. up to bit 12=BO12. If an output is unreliable, the SBC-GPC3 will set the corresponding bit in **RE** to 1. A value of zero indicates that the output is reliable.

Attributes **NT** and **FT** specify a minimum ON and OFF time for the digital input. **NT** defines the minimum time, in seconds, that must elapse after the output is energized before it may be turned off. **FT** specifies the minimum time, in second, that must elapse after the output is turned off before it may be re-energized.

Attribute **PW** specifies a pulse width (0.0-25.5 seconds) that is applied to the digital output while **CV**=1 (on). **PW** allows digital outputs to be in the on state for durations accurate to one-tenth of a second. For example, a pulse width of 5.8 seconds (**PW**=5.8) may have an actual pulse duration of anywhere from 5.7 (**PW**-0.1) to 5.9 seconds (**PW**+0.1). Setting **PW**=0 disables minimum cycle times for the digital outputs and disables pulsed output control.

Attribute **AM** is the automatic/manual mode selection attribute. **AM** determines whether the output value (**CV**) is set: manually or automatically. If **AM**=0 (manual mode), you must manually set **CV** by changing the value through a user interface device (e.g., a host) or an SPL program.

If **AM**=1 (automatic mode), the output is controlled by schedules (F90x), a thermostatic control loop (FA1x), or a floating point control loop (FA2x).

The alarm status attribute, **AS**, defines the current alarm state for the corresponding input. The possible values for **AS** are Normal and Runtime.

When **AS**="Normal", there are no alarms for the digital output. If a runtime alarm is detected **AS** will be set to "Runtime"

Attributes **RH** and **RL** are used for runtime monitoring and alarming. **RH** indicates the number of hours **CV**=1 for the associated digital output. **RL** is the run limit for the input. If **RH** exceeds **RL**, then a run limit alarm will be generated. Setting **RL**=0.0 disables run limit alarms for the input.

Attribute **SM** is the schedule map attribute. You use **SM** to select which schedules are used to control the output directly. When a selected schedule is occupied, the output will be turned on. In addition to using schedules, you can select SmartStat override control and/ or host override control. These option are also selected using the **SM** bitmap. Each bit in **SM** corresponds to a desired control function. These bits are summarized in Table 3-11.

Table 3-9 :Bit options for SM

Bit #	Schedule to Follow
0	F901
1	F902
2	F903
3	F904
4	F905
5	F906
6	F907
7	F908
8	SMARTStat 1
9	SMARTStat 2
10	SMARTStat 3
11	SMARTStat 4
12	SMARTStat 5
13	SMARTStat 6
14	SMARTStat 7
15	SMARTStat 8
16	SMARTStat 9
17	SMARTStat 10
18	SMARTStat 11
19	SMARTStat 12
20	Host Schedule
21	F900
22	FC01

You select one or more of the control options in Table 3-11 by setting the appropriate bit(s) to 1. If you do not want to use schedule control, set all of the bits in **SM** to 0.

Attribute **SI** is the power-on stagger interval. **SI** specifies a delay time (0-255 seconds) that must elapse after the controller is powered up or reset, before the corresponding output can be turned on. If a power on delay time is specified (FF00;PD>0), then the individual **SI** delays do not occur until FF00;PD expires.

Used in conjunction with FF00;PD, multiple SBC-GPC3s on the same network can consecutively stagger their outputs in the event of a network power failure.

Attribute **OU** is a read only attribute that displays the *actual* digital output value. **OU** differs from **CV** in that **CV** reflects the *requested* state of the output. **OU** can differ from **CV** because when the actual output state differs from the current value because of various staging delays.

Attribute **GI** is the GID of the I/O device used as a digital output. If a STATbus device is configured as a digital output, then the global identification number of that device will be displayed in **GI**. Otherwise, GI will display a value of zero.

Digital Outputs 1-12, FB01-FB0C

Attribute	Description
ON	Digital Output Name specifies a user definable string that is used to help identify the channel or its function.
CV	Requested Output Value specifies the current state of output. Because of various delays, this value may differ from OU . 0=Off 1=On
RE	Data Reliability indicates whether the reading from the corresponding digital output is considered reliable. 0=Reliable 1=Unreliable
NT	Minimum On Time specifies the minimum time in seconds that must elapse after the output is energized before it may be turned off.
FT	Minimum Off Time specifies the minimum time in second that must elapse after the output is turned off before it may be re-energized.
PW	Pulse Width when Output is On specifies the "on" time (CV =1) in seconds (0.0 to 25.5) that the output should remain on after a transition from the off to on state. 0=Disabled 0.1-25.5=pulse "on" duration in seconds
AM	Control Mode specifies how the digital output is controlled. 0=Manual 1=Automatic
AS	Alarm Status indicates the alarm state for the input. 0=Normal 10=Runtime
RH	Run Hours indicates the number of hours CV =1 for the input.
RL	Run Hours Limit specifies a number of hours that CV =1 after which a run limit alarm is generated. Setting RL =0.0 disabled run limit alarms for the input.

Attribute	Description
SM	Schedules to Follow enables scheduled alarm controlling for the associated digital output by selecting one or more of the available schedule control channels. 0=Schedule disabled 1=Schedule enabled SM is a bitmap with bit #0=F901 bit #1=F902 bit #2=F903 bit #3=F904 bit #4=F905 bit #5=F906 bit #6=F907 bit #7=F908 bit #8=SMARTStat1 bit #9=SMARTStat2 bit #10=SMARTStat3 bit #11=SMARTStat4 bit #12=SMARTStat5 bit #13=SMARTStat6 bit #14=SMARTStat7 bit #15=SMARTStat8 bit #16=SMARTStat9 bit #17=SMARTStat10 bit #18=SMARTStat11 bit #19=SMARTStat12 bit #20=Host Schedule bit #21=F900 bit #22=FC01
SI	Power-On Stagger Interval specifies the time, in seconds, that must elapse after the controller is turned on or reset before the output can be turned on.
OU	Actual Output Value specifies the actual state of the output. 0=Off 1=On
GI	GID of I/O Device indicated the global identification number of the STATbus device associated with the digital output. If the inputs does not have a STATbus device mapped to it, GI will be 0.

3.12 PID CONTROL 1-12, FA01-FA0C

Proportional + Integral + Derivative (PID) represents a method of control that controls equipment according to a setpoint in proportion to the value of a measured variable. It accounts for the amount of error (difference between the measured variable and the setpoint) and the continued presence of error. Each PID Control channel has the following attributes: **ON**, **SP**, **TS**, **CS**, **DL**, **AO**, **PO**, **IC**, **IA**, **OL**, **OH**, **SR**, **MR**, **RC**, **RA**, **RS**, **RL**, **DB**, **PB**, **RP**, **RT**, **SG**, **SU**, **SM**, and **CE**.

You can use PID control in the analog output loop by enabling the Control Enable attribute (**CE** = 1). Setting **CE** = 0 disables PID control.

Attribute **ON** stores the name of the channel. This is a user definable string that can be used to help identify the channel or, for example, to identify what the loop is controlling.

Attribute **SP** is Loop Setpoint. It specifies the desired loop setpoint. In PID control, the setpoint is defined in **SP**. The measured input variable is the analog sensor referenced by the universal input specified in **IC** and **IA**. The setpoint is expressed in the same kind of measurement units (engineering units) that the measured variable uses (e.g., degrees, cfm, inches of WC, etc.). The data type of **SP** is the same as the data type of the selected measured variable. This value is used with the unoccupied setup/setback and the reset to calculate **CS**.

Attribute **TS** indicates any setpoint adjustments read in from a SmartSTAT. This value is used in calculating the final control setpoint.

Attribute **CS** is Calculated Control Setpoint. It shows the actual loop control setpoint. This read-only point reflects the unoccupied setup/setback as well as any reset and/or SmartSTAT setpoint adjustment. This point is expressed in the same kind of measurement units (engineering units) that the measured variable uses (e.g., degrees, cfm, inches of WC, etc.). The data type of **CS** is the same as the data type of the selected measured variable.

Attribute **DL** indicates the demand load for the control loop. This is the amount by which **CS** differs from the loop measured variable specified in **IC** and **IA**.

Attribute **AO** is Analog Output Value. It shows the scaled output value used by the analog output and is a reflection of the Analog Output attribute **CV**. This point is the **PO** value scaled to **MN** and **MX** of the corresponding analog output **AO**. You can write to attribute **AO** when the Analog Output attribute **AM** = 0.

Attribute **PO** is Percent Output Value. This attribute shows the output value in hundredths of a percent (e.g., 75.00%). The value is calculated based on the error, change in error and past error for the control loop. The point is then scaled to the selected engineering units of the analog output and is stuffed into the **AO** attribute as well as into **CV** of the analog output. This point can be set manually if the control loop is disabled (**CE** = 0).

Attributes **IC** and **IA** specify the channel and attribute to be used as the Loop Measured Variable. It specifies the input to be used for the control loop's measured variable.

NOTE

To clear **IC** and remove the association with its target channel, you must write a value of 0000 (four zeroes) to **IC**.

Attribute **OL** and **OH** define the minimum and maximum limits of the output range for the control loop. The value of **PO** will be scaled between **OL** and **OH** before being sent to the analog output.

Attribute **SR** specifies the soft start ramp. **SR** is the maximum percentage change per minute for the associated output under the following conditions: when the controller is initially powered up or reset; upon transitions from unoccupied to occupied mode, upon cancellation of an interlock failure or fire condition, or when a control loop is initially enabled. These situations can cause the control loop to peg to 100% which can cause the output to spike and, in turn, could lead to equipment damage. To prevent this, the output will be limited to changing **SR** percent per minute. The effects of **SR** are seen in **AO**, but do not effect **PO**.

Attribute **MR** is Maximum Amount to Reset Setpoint. It specifies the maximum amount needed to reset the loop setpoint (**SP**) based on when reset is being used. Attribute **CS** takes into account the use of the maximum reset specified in **MR**.

NOTE

The data type of **MR** is the same as the data type of the referenced input variable specified by **IC** and **IA**.

Attributes **RC** and **RA** specify the channel and attribute to be used as the Reset Variable. It specifies the input to be used for calculating the reset used by the control loop.

Attribute **RS** is the Reset Setpoint. This attribute specifies the value at which the reset action begins. When the value of the reset variable exceeds **RS**, reset action will be used in determining the calculated setpoint. Just as **SP** is the proportional control setpoint for the measured variable, **RS** is the reset control setpoint for the value of the reset variable selected by **RC** and **RA**. The data type of **RS** is the same as the data type of the reset variable specified by **RC** and **RA**.

Attribute **RL** is Limit for Maximum Reset. It specifies the value at which maximum reset is used. When the value of the reset variable is equal to **RL**, the maximum reset (**MR**) is used in determining the calculated setpoint (**CS**).

The relationship between **RL** and **RS**, as well as the sign (+ or -) of **MR**, determines how changes in the reset variable specified by **RC** and **RA** affect the setpoint of the loop **SP**. Refer to Figure 3-3.

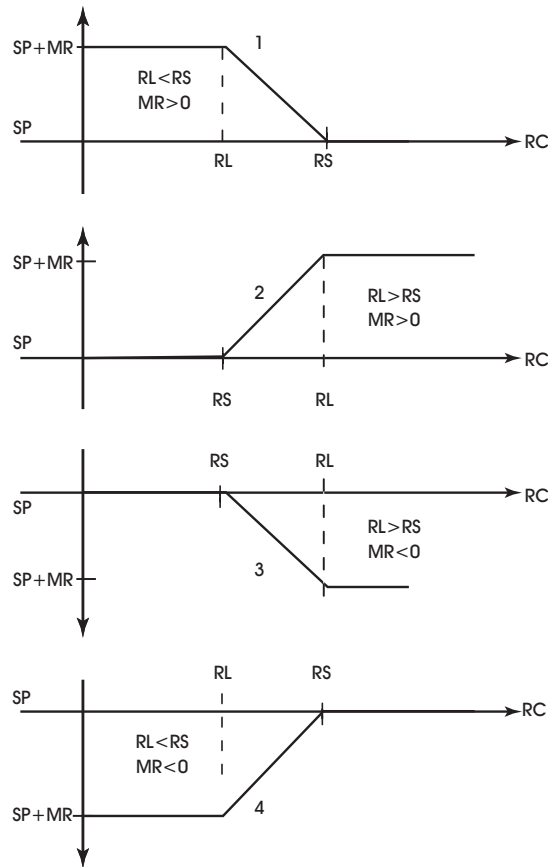

Figure 3-3: Four Forms of Reset Action

NOTE

The data types returned for attributes **RS** and **RL** are determined by the data type of the referenced reset variable specified by **RC** and **RA**.

NOTE

It may not be possible to use a negative value for **MR** if the data type of the control loop's input, specified by **IC** and **IA** uses an unsigned data type.

Attribute **DB** is Dead Band. It specifies the dead band within the proportional control band in which the output remains constant at a point midway between maximum output and minimum output. By specifying a **DB** that is greater than or equal to the resolution of the sensor specified in **IC** and **IA**, you eliminate the possibility of cycling around the setpoint. The value of **DB** should never exceed the proportional band **PB**. If **DB** is greater than **PB**, then the control loop will not have proportional control.

Attribute **DB** is used to specify an input variable range within the proportional band **PB**. The size of **DB** should be based on the type of sensor input selected for the input specified in **IC** and **IA**. When the value of the measured variable is within this dead band, the output signal remains constant at the midpoint of the minimum/maximum range.

The point **DB** is centered on the setpoint **SP** to create the actual control dead band. When the value of the control variable (specified by **IC**) is within $\pm DB/2$ of the setpoint **SP**, the SBC-GPC3 assumes that it has reached the setpoint. Refer to Figure 3-4.

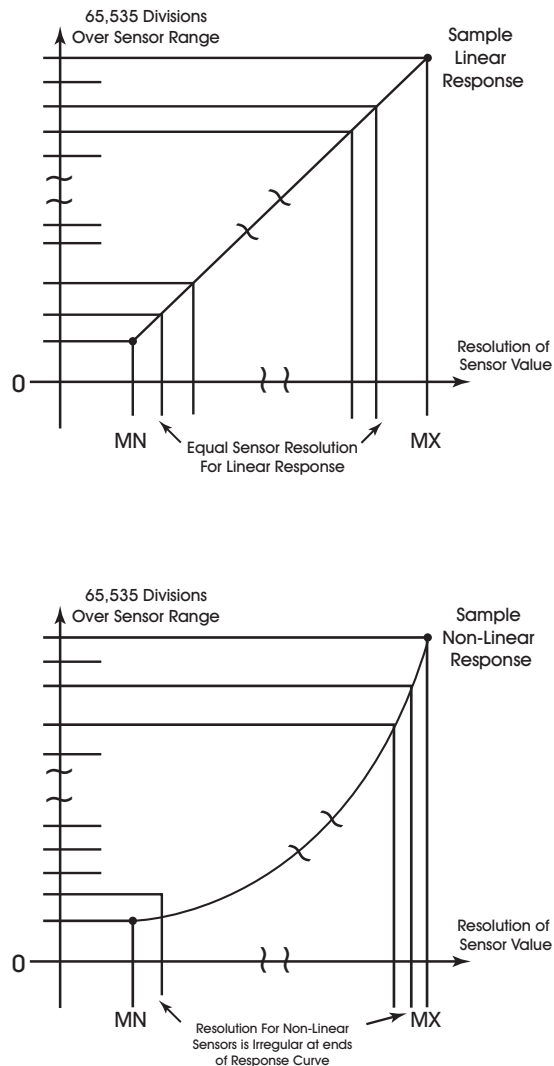

Figure 3-4: Normal Acting, Proportional Control Output Response Showing a Dead Band Centered Around the Setpoint (SP)

By entering a value in **DB** that is greater than the resolution of the measured variable sensor, you create a deadband that allows the SBC-GPC3 to effectively reach setpoint.

Be sure that the **DB** selected does not exceed the size of the proportional band (**PB**). The attribute **DB** is expressed in the same kind of measurement units (engineering units) that the measured variable uses (e.g., degrees, cfm, inches of WC, etc.). The data type of **DB** is the same as the data type of the selected measured variable. The point **DB** defaults to 0.

NOTE

The data types returned for attributes **DB** and **PB** are determined by the data type of the referenced measured variable specified by **IC** and **IA**.

CAUTION

*Never change **DB** to a value greater than half of the proportional band **PB**. Doing so will eliminate the effects of PID control, resulting in on/off control.*

At this point, the SBC-GPC3 will provide simple closed loop feedback proportional control. This means that the actual measured performance of the control (from the measured variable input) is fed back to the controller and is compared with the effective setpoint for the loop. Any difference between the actual value of the measured variable (let's call this MV) and effective setpoint values is called error ($MV - CS$).

An analogy is helpful in explaining the effects of error. Figure 3-5 shows a simple lever and fulcrum. A change in the lever position on the error side produces a proportional change in the lever on the output side. Depending on the position of the fulcrum, a change on the error side will have a greater or lesser effect on the output side. The fulcrum position changes the ratio of error to output.

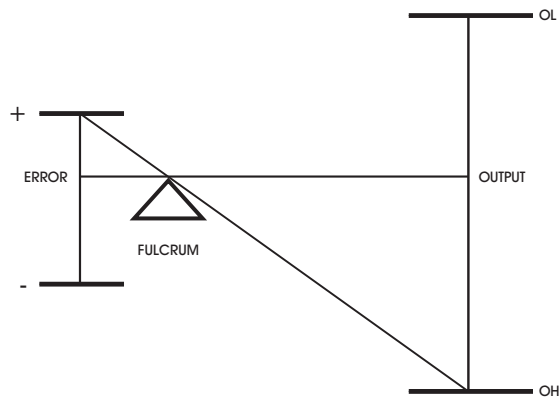

Figure 3-5: Input/Output Ratio

One problem with proportional only control is the changes in loop performance that occur when the condition being measured by the input sensor changes (e.g., the measured temperature changes when a door is opened and the room or space is flooded with cold air). As the loop environment changes, the proportional only control loop begins to cycle around an offset from the setpoint. Figure 3-6 illustrates the performance of a typical loop under proportional only control.

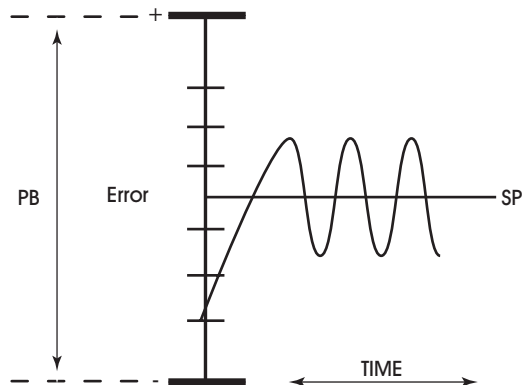

Figure 3-6: Proportional Only Control

Attribute **PB** is Proportional Band. It specifies the input variable range over which the output value is proportional to the error value (i.e., changes in the measured variable result in proportional changes in the output signal). The proportional band is centered around setpoint for the loop. This point is expressed in the same kind of measurement units (engineering units) that the measured variable uses—for example: degrees, cfm, inches of WC. The data type of **PB** is the same as the data type of the selected measured variable

NOTE

The data type of **PB** is the same as the data type of the referenced input variable specified by **IC** and **IA**.

To determine **PB**, first decide how closely the SBC-GPC3 must control the output to the setpoint. For instance, if the setpoint is 72°F, then an acceptable control range might be within two degrees of the setpoint. This control range can be expressed as a band centered on the setpoint: from 70° to 74°, or 4 degrees—the *proportional band (PB)*. Refer to Figure 3-7 and Figure 3-8.

For normal acting control loops (see Figure 3-7), **PO** is set to maximum output when the input variable equals the setpoint plus half of the proportional band ($CS + PB/2$). The point **PO** is set to minimum output when the input variable equals the setpoint minus half of the proportional band ($CS - PB/2$). These associations are reversed for reverse acting control loops. See Figure 3-8. **PO** will be midway between minimum and maximum output when $MV=CS$.

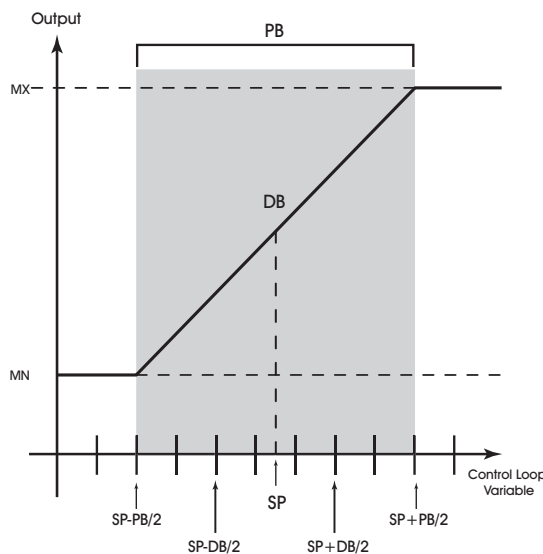

Figure 3-7: Proportional Band for Normal Acting Control (SG = 0)

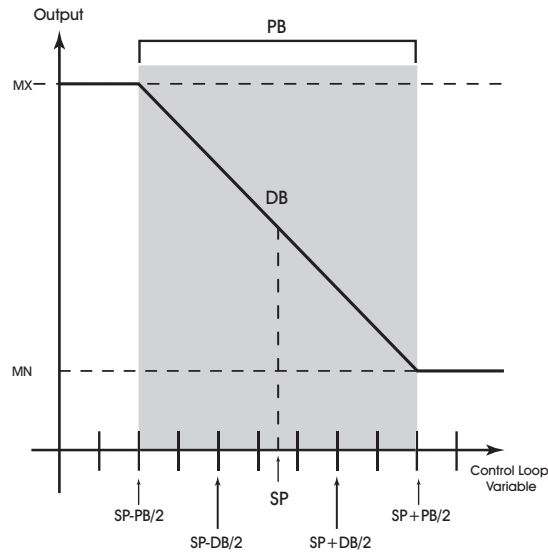

Figure 3-8: Proportional Band for Reverse Acting Control ($SG = 1$)

Attribute **RP** is Reset Period. This attribute specifies the reset period (in seconds) over which the error history is accumulated. If **RP** = 10 seconds with a constant error of 2.0, then the error history would increase by 0.2 every second. In five seconds, the error history would be 1.0. At the end of ten seconds, the error history would be 2.0. Setting **RP** to 0 disables integral action making the loop proportional only. The longer **RP** is, the less effect it has on the control response. Figure 3-9 shows the response of a typical control loop when integral action is used in addition to proportional action (PI control). A value of 0 disables the reset period.

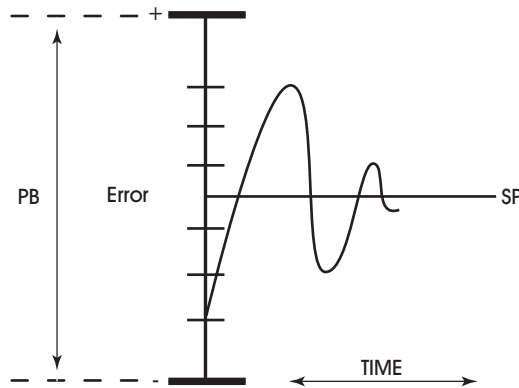

Figure 3-9: Proportional + Integral (PI) Control

At the start-up of the loop or following a change in setpoint (see Figure 3-9), the error is fairly large. Proportional action causes the loop output to accelerate toward the setpoint. However by the time the loop response reaches the setpoint value, it has gained inertia from the preceding proportional action. This causes the loop to overshoot the setpoint moving toward its first peak,

the error sum is accumulating. This slows down the acceleration, eventually causing the downturn in response.

As the error falls and then drops below the setpoint, the error sum will be reduced because now the error is in the opposite direction. The cycle continues in diminishing peaks until it finally converges at the setpoint as shown in Figure 3-9.

The proportional control action of the loop has a major effect on integral action. Increasing **PB** results in a smaller integral effect for a given value of **RP**. In general, decreasing the proportional band, **PB**, will increase the magnitude of the changes in **PO**.

Several important factors may not be obvious to inexperienced users of these DDC techniques.

First, whenever the error falls outside of the proportional band—that is, $\pm \text{PB}/2$ from the setpoint, two important things happen: the controller’s output is fully pegged in the appropriate direction, and the error sum stops accumulating. The control produces its maximum output because it must bring the error within the proportional band again. The error sum is accumulating so that it does not “wind up” a massive error sum that would take many control cycles to dissipate. This feature is called antireset windup.

Antireset windup also makes the loop recover quickly when it reenters the proportional band. Another feature of antireset windup is that the error history is limited to **PB**/2 because that is all that required to produce maximum output. Additional error accumulation would only slow down loop recovery.

To quicken loop response while eliminating overshoot, derivative action must be taken. Derivative action takes into account the rate of change in error and allows the SBC-GPC3 to counter the effects of the error’s rate of change on the control output. To find the change in error, subtract the current error (read every second by the PID loop) from the previous second’s error. A percentage of this change (specified by **RT**) becomes the derivative contribution to the PID output.

Attribute **RT** is Derivative Rate. It specifies a percentage of change in error that is to be used in calculating **PO**. The value is specified in percent per second. The point **RT** can have any value from 0.0 to 25.5%/second. The effect of adding derivative action to the output response appears in Figure 3-10.

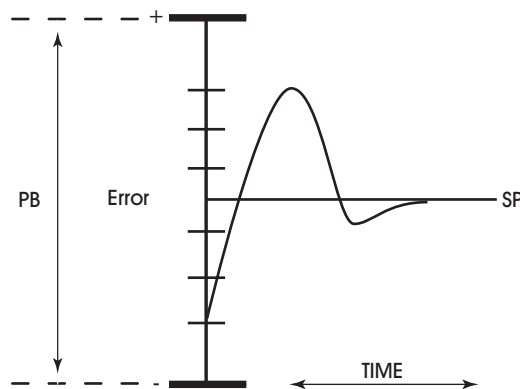

Figure 3-10: Proportional + Integral + Derivative (PID) Control

Attribute **SG** is Control Action. It specifies the control action for the control loop. When **SG** = 0 (normal), a positive error causes an increase in output. When **SG** = 1 (reverse), a positive error causes a decrease in

output. This point determines the response of the loop output to the kind of error. If the output action is to be increased (toward max) when the error is positive ($MV > SP$), set **SG** to normal (0). If the output action is to be decreased (toward min) for positive error, set **SG** to reverse (1). (Attribute **SG** is also used during schedule control to determine whether **SU** is added to **SP** [**SG** = 0] or subtracted from **SP** [**SG** = 1] during unoccupied periods.) For more information, refer to attribute **SU**.

Proportional only control produces cycling, and its performance changes when the measured environment changes. The way to eliminate cycling and to compensate for load changes is to use *integral* action, the *I* part for PID control.

Rather than responding exclusively to the loop error from moment to moment as is the case with proportional action, integral action is based on a summation of the error that has occurred over some period. This error sum is used to reset, or modify, the response of the control loop (output) based on a running average of the error. The amount of time over which the error averaging is accumulated is called the *reset period*.

Attribute **SU** is Unoccupied SetUp/Setback. This point specifies the amount to add (if **SG** = 0) or subtract (if **SG** = 1) from the setpoint during an unoccupied period. The adjusted setpoint will be displayed in **CS**. The attribute **CS** (the effective setpoint incorporates any setup/setback that may exist as well as any reset or setpoint adjustment from the SBC-STAT. The data type of the value specified in **SU** is the same as the data type of the referenced measured variable specified by **IC**.

Attribute **SM** is the schedule map attribute. You use **SM** to select which schedules are used to control the setpoint adjustment of the PID control loop. In addition to using schedules, you can select SmartStat override control and/ or host override control. These option are also selected using the **SM** bitmap. Each bit in **SM** corresponds to a desired control function. These bits are summarized in Table 3-11.

Table 3-10 :Bit options for SM

Bit #	Schedule to Follow
0	F901
1	F902
2	F903
3	F904
4	F905
5	F906
6	F907
7	F908
8	SMARTStat 1
9	SMARTStat 2
10	SMARTStat 3
11	SMARTStat 4
12	SMARTStat 5
13	SMARTStat 6

Table 3-10 :Bit options for SM

Bit #	Schedule to Follow
14	SMARTStat 7
15	SMARTStat 8
16	SMARTStat 9
17	SMARTStat 10
18	SMARTStat 11
19	SMARTStat 12
20	Host Schedule
21	F900
22	FC01

You select one or more of the control options in Table 3-11 by setting the appropriate bit(s) to 1. If you do not want to use schedule control, set all of the bits in **SM** to 0.

Attribute **CE** is Enable Control Loop. It enables the PID loop. When **CE** = 0, **PO** is not updated but may be set manually. When **CE** = 1, **PO** is updated by the PID control loop and if the analog output is set to automatic control, the **AO** value will be set accordingly.

PID Control 1-12, FA01-FA0C

Attribute	Description
ON	Control Loop Name specifies a user definable string that is used to help identify the channel or its function.
SP	Loop Setpoint specifies the desired value of the variable selected in IC and IA .
TS	Thermostat SP Adjustment indicates any setpoint adjustments read in from a SmartSTAT.
CS	Calculated Control Setpoint specifies the effective (calculated) setpoint accounting for setup/setback, manual setpoint adjustments, etc.
DL	Demand Load indicates the demand load for the control loop. This is the amount by which CS differs from the loop measured variable specified in IC and IA .
AO	Analog Output Value displays the output of the PID loop.
PO	Percent Output Value displays the calculated output of the PID control loop. PO ranges from OL to OH .
IC	Loop Measured Channel specifies the input channel to be used as the measured variable for the PID control loop.
IA	Loop Measured Attribute specifies the attribute associated with the channel specified in IC to be used as the measured variable for PID control loop.
OL	Output Low Limit defines the minimum output for the PID control loop.
OH	Output High Limit defines the maximum output for the PID control loop.
SR	Soft Start Ramp specifies the maximum percentage change per minute for the associated output under the following conditions: when the controller is initially powered up or reset; upon transitions from unoccupied to occupied mode and upon cancellation of an interlock failure or fire condition.
MR	Maximum Amount to Reset Setpoint the maximum amount to reset the control loop setpoint.
RC	Reset Channel specifies the input channel to be used as the reset variable for the PID control loop.
RA	Reset Attribute specifies the attribute associated with the channel specified in RC to be used as the reset variable for the PID control loop.

Attribute	Description
RS	Setpoint at which Reset Action Begins specifies the setpoint of the control loop at which reset action begins.
RL	Limit for Maximum Reset specifies the reset limit of the control loop. When RV reaches a value of RL , the control loop setpoint will be reset by the maximum amount RV .
DB	Desired Control Deadband specifies the deadband that is used to control cycling around the setpoint. If the current value of the input channel is between SP -(DB /2) and SP +(DB /2), the measured variable is considered to be at its setpoint.
PB	Proportional Control Band specifies a range, centered around the loop setpoint SP , where the output signal is proportional. If the value of the selected input channel is outside the proportional band, the proportional component of the PID calculation is clamped at OL or OH as appropriate.
RP	Reset Period specifies a time, in seconds (0 to 65,535) over which the output of the control loop should be adjusted (reset) using integral action. 0=Disabled 1 to 65,535=Integral reset period, in seconds
RT	Derivative Rate specifies a percentage of the amount of derivative error that is contributed each second to the PID output of the control loop (0.0 to 25.5%). 0.0=Disable 0.1 to 25.5=Derivative rate in %/second
SG	Control Action specifies whether the controller's output should be increased or decreased when error is positive. 0=Normal (increase for positive error) 1=Reverse (decrease for positive error)
SU	Unoccupied Setup/Setback specifies a value (0.0 to 25.5) which is added to (if SG =1) or subtracted from (if SG =0) the control loop setpoint during scheduled unoccupied periods.

Attribute	Description
<p>SM</p>	<p>Schedules to Follow enables scheduled alarm controlling for the associated PID control loop by selecting one or more of the available schedule control channels.</p> <p>0=Schedule disabled 1=Schedule enabled</p> <p>SM is a bitmap with bit #0=F901 bit #1=F902 bit #2=F903 bit #3=F904 bit #4=F905 bit #5=F906 bit #6=F907 bit #7=F908 bit #8=SMARTStat1 bit #9=SMARTStat2 bit #10=SMARTStat3 bit #11=SMARTStat4 bit #12=SMARTStat5 bit #13=SMARTStat6 bit #14=SMARTStat7 bit #15=SMARTStat8 bit #16=SMARTStat9 bit #17=SMARTStat10 bit #18=SMARTStat11 bit #19=SMARTStat12 bit #20=Host Schedule bit #21=F900 bit #22=FC01</p>
<p>CE</p>	<p>Enable Control Loop? enables/disables PID control.</p> <p>0=No 1=Yes</p>

3.13 THERMOSTATIC CONTROL 1-12, FA11-FA1C

When thermostatic control is enabled, the associated digital output will control the measured variable based on a user-defined setpoint (**SP**). By calculating a control setpoint, which takes into account a possible setup/setback during unoccupied and night setback periods, and comparing it with the measured variable, the controller can determine the amount of output that will be necessary to maintain the desired setpoint. The control loop will enforce a control deadband to prevent hysteresis and can be configured to operate based on a pre-defined schedule. Each Thermostatic Control channel has the following attributes: **ON, CV, SP, TS, CS, DL, IC, IA, DB, SG, CE, SU, SM**, and **OB**.

Attribute **ON** stores the name of the channel. This is a user definable string that can be used to help identify the channel or, for example, to identify what the loop is controlling.

Attribute **CV** indicates the current desired state of the output(s) selected in **OB**.

The thermostatic control channel will control based on the loop setpoint attribute **SP**. This attribute represents the desired measured variable in the area being controlled. The controller will begin with the value in **SP** and, when in unoccupied mode, will apply an amount of setup/setback specified in the unoccupied setup/setback attribute **SU**. This value is then stored in the calculated setpoint attribute **CS**.

Attribute **TS** indicates any setpoint adjustments read in from a SmartSTAT. This value is used in calculating the final control setpoint.

The value of **CS** is compared to the measured variable, specified in **IC** and **IA**. If the measured temperature does not equal the calculated setpoint and is outside of the control deadband specified (**DB**), then action will be taken to correct the temperature.

NOTE

To clear **IC** and remove the association with its target channel, you must write a value of 0000 (four zeroes) to **IC**.

Attribute **DL** indicates the demand load for the control loop. This is the amount by which **CS** differs from the loop measured variable specified in **IC** and **IA**.

Attribute **DB** specifies a control deadband. For a normal action control, this specifies the amount by which the temperature must drop below the cooling setpoint before the output is de-energized. For a reverse action control, this specifies the amount by which the temperature must rise above the heating setpoint before the output is de-energized. This response is illustrated in Figure 3-11.

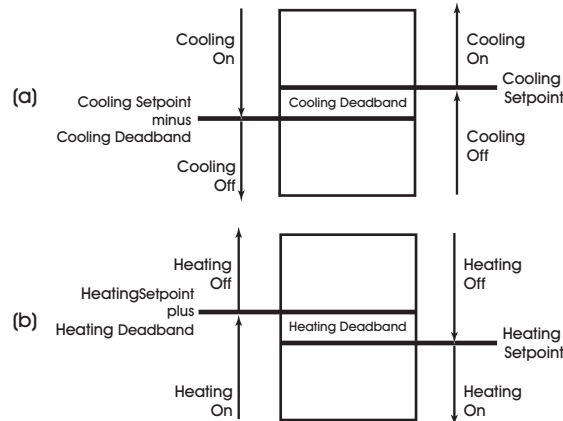

Figure 3-11: Deadband for a Normal Acting (a) and Reverse Acting (b) Thermostatic Control Loop

The sign of the control loop, specified by attribute **SG**, determines whether **SU** is a setup (**SG=0**) or setback (**SG=1**) amount. **CS** (the effective setpoint) incorporates any setup/setback that may exist, as well as any reset or setpoint adjustment from the SmartStat Module.

Attribute **CE** is the control enable attribute and is used to determine whether or not thermostatic control will be active. When **CE=1**, thermostatic control is enabled. If **CE=0**, then the thermostatic control channel will be disabled and no control functions will be performed.

Attribute **SU** is the setup/setback attribute. **SU** specifies a setpoint offset for unoccupied mode. During unoccupied periods (as specified by schedule channels that are selected through the **SM** attribute), the **SP** is either setup or setback by an amount specified in **SU**.

Attribute **SM** is the schedule map attribute. You use **SM** to select which schedules are used to control the setpoint adjustment of the floating point control loop. In addition to using schedules, you can select SmartStat override control and/ or host override control. These options are also selected using the **SM** bitmap. Each bit in **SM** corresponds to a desired control function. These bits are summarized in Table 3-11.

Table 3-11 :Bit options for SM

Bit #	Schedule to Follow
0	F901
1	F902
2	F903
3	F904
4	F905
5	F906
6	F907
7	F908

Table 3-11 :Bit options for SM

Bit #	Schedule to Follow
8	SMARTStat 1
9	SMARTStat 2
10	SMARTStat 3
11	SMARTStat 4
12	SMARTStat 5
13	SMARTStat 6
14	SMARTStat 7
15	SMARTStat 8
16	SMARTStat 9
17	SMARTStat 10
18	SMARTStat 11
19	SMARTStat 12
20	Host Schedule
21	F900
22	FC01

You select one or more of the control options in Table 3-11 by setting the appropriate bit(s) to 1. If you do not want to use schedule control, set all of the bits in **SM** to 0.

Attribute **OB** is used to specify which digital outputs will be controlled by the thermostatic control loop. **OB** is a bitmap with bit 1 corresponding to Digital Output 1, bit 2=Digital Output 2, etc. Setting a bit of **OB** allows the thermostatic control loop to control the corresponding digital output.

NOTE

If an output is already being controlled by another control loop, it may not be selected in **OB**.

Thermostatic Control 1-4, FA11-FA14

Attribute	Description
ON	Thermostatic Control Name specifies a user definable string that is used to help identify the channel or its function.
SP	Loop Setpoint specifies the desired setpoint for the thermostatic control loop.
TS	Thermostat SP Adjustment indicates any setpoint adjustments read in from a SmartSTAT.
CS	Calculated Control Setpoint specifies the calculated (actual) control setpoint that is used by the thermostatic control loop. CS accounts for the effects of setup/setback (SU) during scheduled unoccupied periods.
DL	Demand Load indicates the demand load for the control loop. This is the amount by which CS differs from the loop measured variable specified in IC and IA .
IC	Loop Measured Channel specifies the input channel to be used as the measured variable for the Thermostatic control loop.
IA	Loop Measured Attribute specifies the attribute associated with the channel specified in IC to be used as the measured variable for Thermostatic control loop.
DB	Desired Control DeadBand specifies a control hysteresis that is used to keep CV from toggling when the value is on the border between two states.
SG	Control Action specifies the control sign for the thermostatic control application. 0=Cooling 1=Heating
CE	Enable Control Loop? enables/disables thermostatic control for the associated control loop. 0=Disabled 1=Enabled
SU	Unoccupied Setup/Setback specifies a value (0.0 to 25.5) which is added to the control setpoint during scheduled unoccupied periods.

Attribute	Description
SM	<p>Schedules to Follow enables scheduled alarm controlling for the thermostatic control loop by selecting one or more of the available schedule control channels. 0=schedule disabled 1=schedule enabled</p> <p>SM is a bitmap with bit #0=F901 bit #1=F902 bit #2=F903 bit #3=F904 bit #4=F905 bit #5=F906 bit #6=F907 bit #7=F908 bit #8=SMARTStat1 bit #9=SMARTStat2 bit #10=SMARTStat3 bit #11=SMARTStat4 bit #12=SMARTStat5 bit #13=SMARTStat6 bit #14=SMARTStat7 bit #15=SMARTStat8 bit #16=SMARTStat9 bit #17=SMARTStat10 bit #18=SMARTStat11 bit #19=SMARTStat12 bit #20=Host Schedule bit #21=F900 bit #22=FC01</p>
OB	<p>Output Bitmap specify which digital outputs will be controlled by the thermostatic control loop. bit #0=BO1 bit #1=BO2 bit #2=BO3 bit #3=BO4 bit #4=BO5 bit #5=BO6 bit #6=BO7 bit #7=BO8 bit #8=BO9 bit #9=BO10 bit #10=BO11 bit #11=BO12</p>

3.14 FLOATING POINT CONTROL 1-2, FA21-FA22

Channels FA21 and FA22 are used to configure floating point control channels 1 and 2 of the SBC-GPC3. Each of these channels contains the following attributes: **ON, SP, TS, CS, DL, DP, CP, IC, IA, MR, RC, RA, DO, RS, RL, DB, PB, RP, SG, TT, SU, SM, IL, CF, FP, FI, PE, CR, CE,** and **RI**.

In floating point control applications, each floating point control channel controls the position of a motor actuator using two digital outputs (an increase output and a decrease output).

If the desired position of the motor (**DP**) is greater than the current position, the controller will drive the motor open by turning on the “increase” output for a calculated period of time. If the desired position is less than the current position, the controller will drive the motor closed by turning on the “decrease” output for a calculated period of time.

The desired position of the floating point control channel can be set manually or calculated automatically by the PI algorithm. The automatic floating point control algorithm operates as follows. When the value of the selected measured variable is within the control loop’s deadband, no control action is taken by the PI loop. When the value of the measured variable is outside the deadband, but within a programmable proportional band, the output is modulated using PI control according to the setpoint of the control loop. When the value of the measured variable is outside the deadband and beyond (either above or below) the proportional band, the output is set to either 0% or 100%, as appropriate.

NOTE

To use floating point control loops, you must configure the associated digital outputs for automatic control (**AM=1**).

Attribute **TT** is the motor travel time attribute. **TT** is used to specify the total time in seconds (0 to 65,535 seconds) that it takes the motor actuator to go full stroke (from fully open to fully closed). **TT** is used to determine the current position (**CP**) of the motor. **TT** defaults to a value of 0 seconds.

NOTE

The travel time of a motor depends on the load that is applied to the motor. For accuracy, it is suggested that you determine **TT** when the motor is *loaded*.

NOTE
<p>For spring loaded motors, the full stroke travel time from 0% to 100% may be different than the 100% to 0% travel time. You may choose to use the higher of the two travel times for TT. In this case, it is recommended that you perform regular calibrations on the motor.</p>

Attribute **PE** is the pair enable attribute. This attribute is used to enable the pair of digital outputs for floating point control. If **PE=0**, the corresponding floating point control pair is disabled. If **PE=1**, then the corresponding floating point control pair is enabled.

Attribute **DO** is used to select the pair of digital outputs to be controlled by the floating point control loop. Output pairs are often used with floating point actuators which respond to increase/decrease signals. The options for **DO** are given in Table 3-12.

Table 3-12 : Digital Output Pair Selection Options

DO	Output Pair Selected
0	none
1	DO1+DO2
2	DO3+4
3	DO5+6
4	DO7+8
5	DO9+10
6	DO11+12

The first output listed is the “increase” signal and the second output listed is the “decrease” signal.

Attribute **CE** is the control enable attribute. **CE** is used to determine how the desired position of the control loop is determined. **CE=0** means that **DP** is set manually. **CE=1** means that **DP** is calculated automatically by the PI algorithm.

Attribute **DL** indicates the demand load for the control loop. This is the amount by which **CS** differs from the loop measured variable specified in **IC** and **IA**.

NOTE

To clear **IC** and remove the association with its target channel, you must write a value of 0000 (four zeroes) to **IC**.

Attribute **TS** indicates any setpoint adjustments read in from a SmartSTAT. This value is used in calculating the final control setpoint.

Attribute **ON** stores the name of the channel. This is a user definable string that can be used to help identify the channel or, for example, to identify what the loop is controlling.

3.14.1 PI CONTROL

PI stands for *proportional + integral* and represents a method of control which controls equipment according to a setpoint in proportion to the value of a measured variable. It also accounts for the amount of error (difference between the measured variable and the setpoint). PI control can be used in floating point control loops by enabling the control enable attribute (**CE=1**). PI control is disabled by setting **CE=0**. PI control is a subset of PID control (PID minus the derivative control). Refer to the descriptions of channels FA01 through FA0C for an in depth study of PI (and PID) control.

Attribute **SP** is the desired control loop setpoint attribute. In PI control, the setpoint is defined in **SP**, and the measured input variable is the analog sensor referenced by the universal input channel specified in **IC** and **IA**. The setpoint is expressed in the same kind of measurement units (Engineering Units) that the measured variable uses (e.g., degrees, cfm, inches of WC, etc.). For example, if you are using the floating point control channel to adjust cooling dampers to control a temperature value that the input sensor measures in degrees, the setpoint for the floating point control channel must also be expressed in degrees. The data type of **SP** is the same as the data type of the selected measured variable.

Attribute **CS** is the calculated control loop setpoint. Unlike **SP**, **CS** is a read only value that reflects any setup or setback that may be applied (during unoccupied modes), as well as any reset or setpoint adjustments made through a STAT. **CS** is the actual setpoint that is used by the control loop. Refer to attributes **SU** and **SM** for more information about schedule controlled setup/setback. **CS** is expressed in the same kind of measurement units (Engineering Units) that the measured variable uses (e.g., degrees, cfm, inches of WC, etc.). The data type of **CS** is the same as the data type of the selected measured variable.

Attribute **DP** is the desired position attribute. **DP** specifies the desired position of the floating setpoint motor output in percent (e.g., 50%). **DP** is set automatically by the floating point control loop when it is enabled (**CE=1**). **DP** can be set manually if **CE=0**. **DP** specifies the desired motor position to which the floating point control loop should control the outputs in order to bring the measured input value (specified by **IC** and **IA**) closer to the calculated setpoint value (**CS**). **DP** can be set automatically by the PI control loop (**CE=1**) or manually from a host (**CE=0**).

Attribute **CP** is the current position attribute. **CP** is the current (actual) position of the motor in percent (e.g., 50%). This value is calculated based on **TT** since the actuator itself has no feedback. To ensure that the actual motor position is the same as **CP**, the motor must occasionally be recalibrated. For information about calibration, refer to attributes **TT**, **CR** and **RI**.

Attribute **IC** and **IA** selects the channel and attribute that is used as the measured variable (**MV**) in the control loop.

NOTE

To clear **IC** and remove the association with its target channel, you must write a value of 0000 (four zeroes) to **IC**.

Attribute **DB** is the deadband attribute. **DB** is used to specify an input variable range within the proportional band **PB**. The size of **DB** should be based on the type of sensor input that is selected for the input channel specified in **IC** and **IA**. When the value of the measured variable is within this deadband, there is no change in the proportional output response.

DB is centered on the setpoint **SP** to create the actual control deadband. When the value of the control variable (specified by **IC** and **IA**) is within $\pm\text{DB}/2$ of the setpoint **SP**, the SBC-GPC3 assumes that it has reached the setpoint.

By entering a value in **DB** that is greater than the resolution of the measured variable sensor, you create a deadband that allows you to effectively reach an otherwise (possibly) unattainable setpoint. Be sure that the **DB** you select does not exceed the size of your proportional band (**PB**). This would cause the output of the control loop to jump from 0% to 100% and vice versa when the value of the loop's control variable exceeds the limits of **PB**, probably not a desired result.

DB is expressed in the same kind of measurement units (Engineering Units) that the measured variable uses (e.g., degrees, cfm, inches of WC, etc.). The data type of **DB** is the same as the data type of the selected measured variable. **DB** defaults to a value of 0.

Attribute **PB** is the proportional band attribute. **PB** defines an input variable range over which the output signal is proportional (i.e., changes in the measured variable result in proportional changes in the desired output). **PB** is expressed in the same kind of measurement units (Engineering Units) that the measured variable uses (e.g., degrees, cfm, inches of WC, etc.). The data type of **PB** is the same as the data type of the selected measured variable.

To determine **PB**, you must first decide how close the SBC-GPC3 must control the output to the setpoint. For instance, if the setpoint is 72°F., an acceptable control range might be within two degrees of the setpoint. This control range can be expressed as a band centered on the setpoint: from 70° to 74°, or four degrees, the *proportional band* (**PB**). Refer to Figure 3-12 and Figure 3-13.

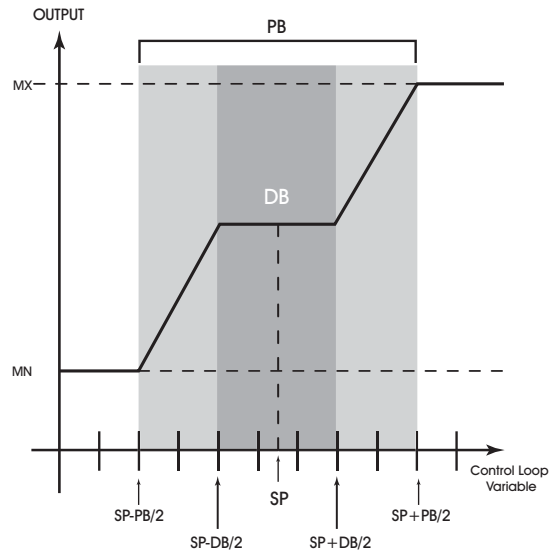

Figure 3-12: Proportional Band For Normal Acting Control ($SG=0$)

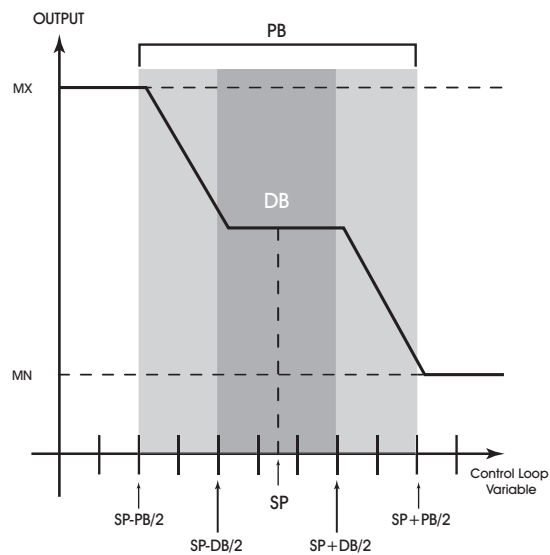

Figure 3-13: Proportional Band For Reverse Acting Control ($SG=1$)

WARNING

You should never change **DB** to a value greater than half of the proportional band **PB**. Doing so will eliminate the effects of PI control, resulting in on/off control.

Attribute **SG** refers to the control sign of the floating point control loop. The control sign is used to determine whether the control loop is *normal acting* or *reverse acting*. A normal acting control loop causes an increase in output position when the value of the input variable *increases* (see Figure 3-12). A reverse acting control loop causes an increase in output position when the value of the input variable *decreases* (see Figure 3-13).

Attribute **SG** is also used during schedule control to determine whether **SU** is added to **SP** (**SG=0**) or subtracted from **SP** (**SG=1**) during unoccupied periods. For more information, refer to attributes **SU** and **SM**.

At this point, the SBC-GPC3 will provide simple closed loop feedback *proportional* control. This means that the actual measured performance of the control (from the measured variable input) is fed back to the controller and compared with the effective setpoint for the loop. Any difference between the actual value of the measured variable (MV) and effective setpoint values is called *error* ($MV \times CS$).

An analogy is helpful in explaining the effects of error. Figure 3-14 shows a simple lever and fulcrum. A change in the lever position on the error side produces a proportional change in the lever on the output side. Depending on the position of the fulcrum, a change on the error side will have a greater or lesser effect on the output side. The fulcrum position changes the ratio of error to output.

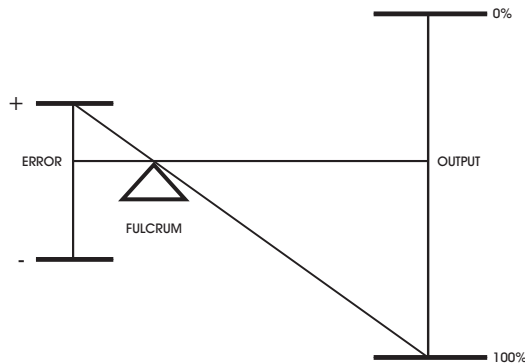

Figure 3-14: Ratio of Input to Output

One problem with proportional-only control is that loop performance changes when the condition being measured by the input sensor changes (e.g., the measured temperature changes when a door is opened and the room or space is flooded with cold air). As the loop environment changes, the proportional only control loop begins to cycle around an offset from the setpoint. Figure 3-15 illustrates the performance of a typical loop under proportional only control.

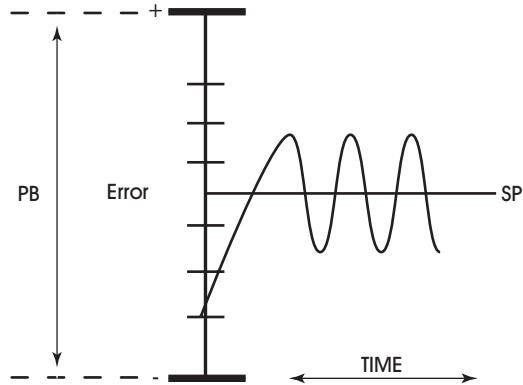

Figure 3-15: Proportional Only Control

Proportional-only control produces cycling, and its performance changes when the measured environment changes. The way to eliminate cycling and to compensate for load changes is to use *integral* action, the *I* part of PI control.

Rather than responding exclusively to the loop error from moment to moment, as with proportional action, integral action is based on a summation of the error which has occurred over some period of time. This error sum is used to reset, or modify, the response of the control loop (output) based on a running average of the error. The amount of time over which the error averaging is accumulated is called the *reset period*.

Attribute **RP** is the reset period attribute. **RP** specifies the reset period (in seconds) over which the error averaging is accumulated. The longer **RP** is, the less effect it has on the control response. Figure 3-16 shows the response of a typical control loop when integral action is used in addition to proportional action (PI control). A value of zero disables the reset period.

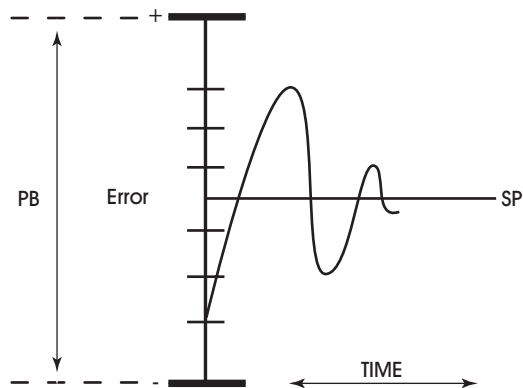

Figure 3-16: Proportional + Integral (PI) Control

The proportional control action of the loop has a major effect on integral action. Increasing **PB** results in a smaller integral effect for a given value of **RP**. In general, decreasing the proportional band, **PB**, will increase the amount of overshoot. On the other hand, the larger **PB** is, the slower the loop will respond.

3.14.2 RESET FEATURE

Attributes **MR**, **RC**, **RA**, **RS** and **RL** control the reset feature (not to be confused with the reset period) of the associated floating point control channel.

Attribute **MR** is the maximum reset attribute. **MR** allows you to specify a maximum amount to reset the loop setpoint **SP**. Attribute **CS** takes into effect the use of maximum reset specified in **MR**.

NOTE

The data type of the **MR** attribute is the same as the data type of the referenced input variable specified by **IC** and **IA**.

Attributes **RC** and **RA** allows you to specify the reset variable that is to be used by the control loop. This attribute gives you the ability to control a loop using one input while resetting the loop using a different input. Throughout this section, V_R refers to the actual value of the reset variable selected by **RV**.

Attribute **RS** is the reset setpoint attribute. **RS** allows you to specify the reset setpoint value at which reset action will occur. Just as **SP** is the proportional control setpoint for MV, **RS** is the reset control setpoint for V_R . The data type of **RS** is the same as the data type of the reset variable specified by **RC** and **RA**.

Attribute **RL** is the reset limit of the control loop. When the reset variable specified by **RC** and **RA** reaches a value of **RL**, the control loop setpoint will be reset by the maximum amount **MR**.

NOTE

The data type returned for attributes **RS** and **RL** are determined by the data type of the referenced reset variable specified by **RC** and **RA**.

NOTE

It may not be possible to use a negative value for **MR** if the data type of the control loop's input channel, specified in **IC** and **IA** uses an unsigned data type.

The relationship between **RL** and **RS**, as well as the sign (+ or -) of **MR**, determines how changes in the reset variable specified in **RC** and **RA** affect the setpoint of the loop **SP**. Refer to figure Figure 3-17.

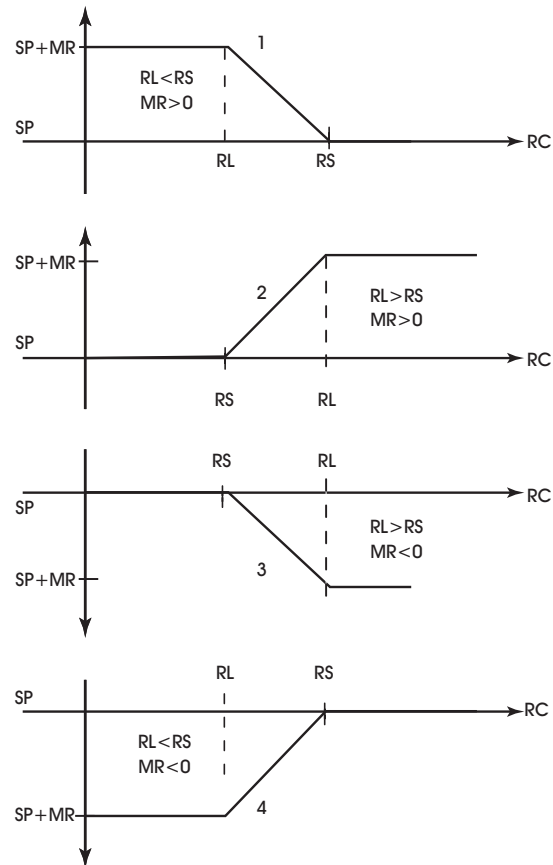

Figure 3-17: Four Forms Of Reset Action

3.14.3 SCHEDULE CONTROL

The floating point control channels of the SBC-GPC3 can be controlled using schedule channels F900 through F908, as well as the SmartStat occupancy override and a host override feature. When enabled, schedule control increases or decreases the control loop setpoint by a programmable amount when the selected schedule channels enter *unoccupied mode*.

Unoccupied mode is a programmable time period during selected days of the week when control constraints are typically less stringent. For example, in a typical office building, the occupied period might be from 8:00 am to 6:00 pm, Monday through Friday. The other times during the week (Monday through Friday from 12:00 midnight to 7:59 am, from 6:01 pm to 11:59 pm, and all day Saturday and Sunday) would be the unoccupied periods. The control constraints can be less stringent at these times because people are not expected to be in the building.

Attribute **SU** is the setup/setback attribute. **SU** specifies a setpoint offset for unoccupied mode. During unoccupied periods (as specified by schedule channels that are selected through the **SM** attribute), the **SP** is either setup or setback by an amount specified in **SU**. The sign of the control loop (**SG**) determines whether **SU** is a setup (**SG=0**) or setback (**SG=1**) amount. **CS** (the effective setpoint) incorporates any setup/setback that may exist, as well as any reset or setpoint adjustment from the SmartStat Module. The

data type of the value specified in **SU** is the same as the data type of the referenced measured variable specified by **IC** and **IA**.

Attribute **SM** is the schedule map attribute. You use **SM** to select which schedules are used to control the setpoint adjustment of the floating point control loop. In addition to using schedules, you can select SmartStat override control and/ or host override control. These option are also selected using the **SM** bitmap. Each bit in **SM** corresponds to a desired control function. These bits are summarized in Table 3-13.

Table 3-13 :Bit options for SM

Bit #	Schedule to Follow
0	F901
1	F902
2	F903
3	F904
4	F905
5	F906
6	F907
7	F908
8	SMARTStat 1
9	SMARTStat 2
10	SMARTStat 3
11	SMARTStat 4
12	SMARTStat 5
13	SMARTStat 6
14	SMARTStat 7
15	SMARTStat 8
16	SMARTStat 9
17	SMARTStat 10
18	SMARTStat 11
19	SMARTStat 12
20	Host Schedule
21	F900
22	FC01

You select one or more of the control options in Table 3-13 by setting the appropriate bit(s) to 1. If you do not want to use schedule control, set all of the bits in **SM** to 0.

If one or more of the schedule bits (bits 0-7) are set in **SM**, then the unoccupied mode setpoint adjustment is based on schedule channels F901-F908. If all of the selected schedules are in unoccupied mode (F90x;**CV**=0), then the corresponding **SU** value is incorporated into the effective setpoint of the control loop (**CS**).

If the SmartStat override bit (bit 9) is set in **SM**, then the SmartStat can be used to extend occupied mode.

If the host override bit (bit 10) is set in **SM**, then you can control the schedule state of the floating point control loop from the Schedule Summary channel (F900). In this case, the host schedule enable attribute must be enabled (F900;**HE**=1).

If the SmartStat Override bit and multiple schedule bits are set in **SM**, the SBC-GPC3 checks the states of the selected schedules and SmartStat pushbutton. If any of the selected schedules has its **CV**=2 or if the SmartStat indicates the zone is occupied, then the control loop uses its occupied mode setpoint. If all of these selected control options indicate that the control loop should be in unoccupied mode, then the control loop incorporates the appropriate setup/setback value into its effective setpoint for unoccupied mode operation.

If the host override is selected (bit 10 of **SM**=1) and enabled (F900;**HE**=1), then F900;**HO** is solely responsible for determining the schedule state of the control loop, regardless of the settings of selected schedules or the state of the SmartStat.

3.14.4 INTERLOCK, COMMUNICATIONS AND FIRE FAILURE POSITIONING

Attribute **IL** is the input interlock bitmap attribute. **IL** is used in conjunction with **FP** for floating point control interlocking. Each bit (1-32) in the **IL** bitmap corresponds to a universal input channel of the SBC-GPC3.

NOTE

To be used for interlocking, the universal input must be configured as a digital input.

One or more of these inputs can be selected as interlocks by setting the corresponding bit in **IL** to 1. In the event that any of the digital inputs specified in **IL** has a value of 1, then the desired position (**DP**) assumes its interlock failure position (**FP**). All of the inputs specified in **IL** must have a current value of 0 before normal control is restored to **CV**.

Attribute **CF** is the communications failure enable attribute. In the event that the floating point control loop is being controlled by a host, you can enable communications failure checking. If **CF**=0 (disabled), then host communications failure checking is disabled. If **CF**=1, then host communications failure checking is enabled.

If **CF**=1 and a host communications failure occurs (after FF00;**CF** has expired), the floating point control loop reverts to the position specified in the failure position attribute (**FP**).

Attribute **FP** is the failure position attribute. **FP** specifies the desired position (**DP**) should an interlock or communications failure occur. An interlock failure occurs when the value of any of the bits set in **IL** equals 1. For more information, refer to **IL**. A communications failure occurs when a host stops communicating

with the SBC-GPC3 for a number of seconds specified in FF00;CF.

Attribute **FI** is the fire position attribute. In the event of a fire condition (FF00;FA bit #0=1), the desired position (**DP**) reverts to the position specified in the fire position attribute (**FI**).

NOTE
<p>If a communications failure or interlock failure occurs, then the desired position of the floating point control loop reverts to FP. If a fire condition then occurs while the communications or interlock failure is still active, FI takes priority over FP.</p>

3.14.5 CALIBRATION

The actuator can also be manually calibrated by enabling floating point control (**PE**=1), disabling PI control (**CE**=0) and setting **DP** to 0% or 100%. When the actuator is at the programmed position (after approximately **TT** seconds), set **CP** to 0% or 100% accordingly. Finally, be sure to return PI control (**CE**=1) if you want **DP** to be set automatically.

Floating point control loops can be calibrated automatically by the SBC-GPC3 at programmable intervals. This is done using the recalibrate interval attribute (**RI**). **RI** is the recalibrate interval that specifies how often (if at all) the associated floating point control channel is to be recalibrated.

RI is given in hours (0-255 hours). If **RI**=0, then recalibration of floating point control loops does not occur. If **RI**>0, recalibration of the associated floating point control loops occurs every **RI** hours.

The SBC-GPC3 recalibrates the floating point control loops by driving the desired position (**DP**) to the fully closed position (0%) for the amount of time specified in the travel time attribute (**TT**). The SBC-GPC3 then sets the current position to 0%, after which the recalibration is complete and the controller returns the desired position to its original value.

For floating point control channels, you can enable an automatic creep feature using attribute **CR**, the creep enable attribute. This feature is used to automatically calibrate the output when its desired position is either 0% or 100%. The automatic creep feature is performed in one of two ways: (1) the appropriate output is left on when the output signal is at 0% or 100%, or (2) the output is *creeped* (pulsed) at a rate of 1% per minute (the current position is set to 1% or 99%) when the output signal is at 0% or 100%. The value of the creep enable attribute (**CR**) selects the desired method.

These two methods of output correction (continuous on and automatic creep) are illustrated in Figure 3-18. This example shows a floating point control loop with a desired position of 100%.

Output correction is the same for desired positions of 0%, only the “close” output (rather than the “open” output) of the pair is used

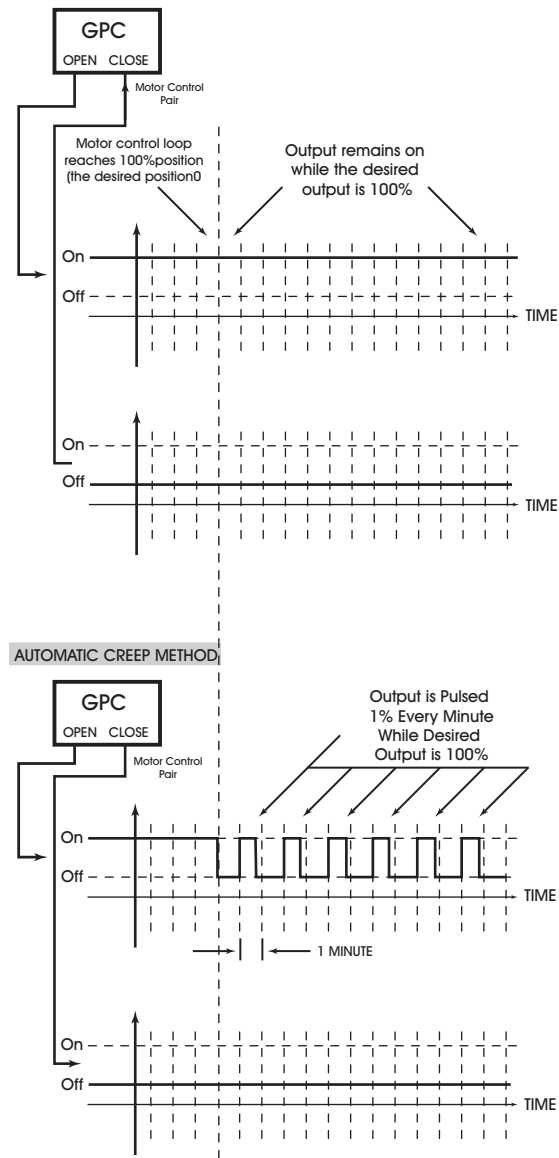

Figure 3-18: Output Correction, Continuous and Automatic Creep

Floating Point Control 1-2, FA21-FA22

Attribute	Description
ON	Floating Point Name specifies a user definable string that is used to help identify the channel or its function.
SP	Loop Setpoint specifies the desired setpoint for the floating point control loop.
TS	Thermostat SP Adjustment indicates any setpoint adjustments read in from a SmartSTAT.
CS	Calculated Control Setpoint indicates the calculated control setpoint. This value accounts for any reset or setup/setback action on the loop setpoint.
DL	Demand Load indicates the demand load for the control loop. This is the amount by which CS differs from the loop measured variable specified in IC and IA .
DO	Digital Output Pair Selection specifies which Digital Output pair is to be used for floating point control. 0=none 1=D01+D02 2=D03+4 3=D05+6 4=D07+8 5=D09+10 6=D011+12
DP	Desired Position specifies the desired output position (0-100%) of the associated motor.
CP	Current Position indicates the current position of the motor.
IC	Input Channel specifies the attribute associated with the channel specified in IC to be used for floating point control.
IA	Input Attribute specifies the channel to be used for floating point control.
MR	Maximum Amount to Reset Setpoint specifies the maximum amount o reset SP .
RC	Reset Channel specifies the channel to be used to determine reset.
RA	Reset Attribute specifies the attribute associated with the channel specified in RV to determine reset.
DO	
RS	Setpoint at which Reset Action Begins specifies the setpoint of the control loop at which reset action begins.

Attribute	Description
RL	Limit for Maximum Reset specifies the reset limit of the control loop. When the reset variable specified in RV and RA reaches a value of RL , the control loop setpoint will be reset by the maximum amount MR .
DB	Desired Control Deadband specifies the deadband that is used to control cycling around the setpoint. If the current value of the input channel is between SP-(DB/2) and SP+(DB/2) , the measured variable is considered to be at its setpoint
PB	Proportional Control Band specifies a range, centered around the loop setpoint SP , where the output signal is proportional.
RP	Reset Period specifies a time, in seconds (0 to 65,535) over which the output of the control loop should be adjusted (reset). 0=Disabled 1 to 65,535=Reset period, in seconds
SG	Control Action specifies whether the controller's output should be increased or decreased when the control signal is positive. 0=Normal (increase for positive error) 1=Reverse (decrease for positive error)
TT	Motor Travel Time specifies the time, in seconds (0-3000), that it takes the motor to move from its fully closed to its fully open positions.
SU	Unoccupied Setup/Setback specifies a value (0.0 to 25.5) which is added to (if SG=1) or subtracted from (if SG=0) the control loop setpoint during scheduled unoccupied periods

Attribute	Description
SM	<p>Schedules to Follow enables scheduled alarm controlling by selecting one or more of the available schedule control channels.</p> <p>0=Schedule disabled 1=Schedule enabled</p> <p>SM is a bitmap with bit #0=F901 bit #1=F902 bit #2=F903 bit #3=F904 bit #4=F905 bit #5=F906 bit #6=F907 bit #7=F908 bit #8=SMARTStat1 bit #9=SMARTStat2 bit #10=SMARTStat3 bit #11=SMARTStat4 bit #12=SMARTStat5 bit #13=SMARTStat6 bit #14=SMARTStat7 bit #15=SMARTStat8 bit #16=SMARTStat9 bit #17=SMARTStat10 bit #18=SMARTStat11 bit #19=SMARTStat12 bit #20=Host Schedule bit #21=F900 bit #22=FC01</p>
IL	<p>Input for Interlock specifies which inputs are to be used for interlocking of the associated floating point control loop.</p> <p>bit #0=FE01 bit #1=FE02 bit #2=FE03 bit #3=FE04 bit #4=FE05 bit #5=FE06 bit #6=FE07 bit #7=FE08 bit #8=FE09 bit #9=FE0A bit #10=FE0B bit #11=FE0C bit #12=FE0D bit #13=FE0E bit #14=FE0F bit #15=FE10 bit #16=FE11 bit #17=FE12 bit #18=FE13 bit #19=FE14 bit #20=FE15 bit #21=FE16 bit #22=FE17 bit #23=FE18 bit #24=FE31 bit #25=FE32 bit #26=FE33 bit #27=FE34 bit #28=FE35 bit #29=FE36 bit #30=FE37 bit #31=FE38</p>

Attribute	Description
CF	<p>Communication Failure Enable? specifies what action to take in the event that a communication failure is detected.</p> <p>0=No 1=Yes</p>
FP	<p>Interlock/Comm Failure Position specifies the failure position (0-100%) to use when an input interlock failure occurs. FP is used when the current value of any of the inputs specified by IL has a value of 1.</p>
FI	<p>Fire Position specifies the failure position (0-100%) to use when a fire event is detected.</p>
PE	<p>Floating Point Controlled Pair Enable specifies whether the motor is to be controlled using pulsed pairs.</p> <p>0=No 1=Yes</p>
CR	<p>Motor Creep Function specifies how the controller handles automatic calibrations at minimum and maximum positions.</p> <p>0=Drive motor constantly if DP=0% or DP=100% 1=Creep motor output by 1% per minute if DP=0% or DP=100%</p>
CE	<p>Enable Control Loop? enables/disables floating point control for the associated control loop.</p> <p>0=No 1=Yes</p>
RI	<p>Motor Recalibrate Interval specifies a time interval in hours (0-255) the defines how often the associated floating point control loop is recalibrated.</p> <p>0=Calibration disabled RI > 0 =Recalibrate every RI hours</p>

3.15 SCHEDULE SUMMARY, F900

The Schedule Summary channel is used to monitor the schedules on the SBC-GPC3. The Schedule Summary channel has the following attributes: **ON, CV, C1, C2, C3, C4, C5, C6, C7, C8, HO, HE, DH, H0, H1, H2, H3, H4, H5, H6, H7, H8, H9, IS, AS,** and **ZE**.

Attribute **ON** stores the name of the channel. This is a user definable string that can be used to help identify the channel or, for example, to identify what the schedule represents.

The current schedule state of the controller displayed in the **CV** attribute. The possible values of **CV** are given in Table 3-14.

Table 3-14 :Options for CV

CV	Schedule
0	Unoccupied
1	Warmup
2	Occupied
3	Night Setback

Attributes **C1** through **C8** display the current state of channels F901 through F908 respectively. The possible values of **C1** through **C8** are the same as for **CV**.

Attribute **HO** displays the current status of the host schedule. This is the value received by the controller from the host when the Enable Host Schedule attribute is set to true (**HE=1**).

Attribute **HE** sets the SBC-GPC3 to use a schedule which is broadcast by a host unit.

Attribute **DH** indicates whether or not today is a holiday. If the current date (FF00;**DT**) is equal to one of the scheduled holidays (**H0-H9**), then **DH** will be true.

Attributes **H0** through **H9** are used to specify holidays entered in the form MM/DD/YYYY.

Attribute **IS** is used to specify the inactive state for the schedules. This is the schedule mode that the controller will default to if there are no schedules which are currently active.

Attribute **AS** shows the schedules which are currently active in the controller. **AS** is a bitmap with bit #1 corresponding to F901, bit #2=F902, up to bit #8=F908.

3.15.1 ZONE SCHEDULING

The GPC provides a set of attributes that can be used with an SPL program to provide a robust zone scheduling application.

Attribute **SO** shows the state of each SBC-STAT's local override flag. The state of the flag is controlled locally at the SBC-STAT interface through the User Menu or through the use of the setpoint keys. An occerride command from the local interface will only be allowed if the corresponding bit for the STAT from F900;**EA** is set to 0 ro disable the remote access button and the F900;**AM** bit is seto to 0 for Auto mode. The **SO** attribute will not reflect a manual override from F900;**OM**.

Attribute **AB** displays the state of the remote access control buttons. Writes to this attribute are always permitted regardless of the value displayed in F900;**EA**

Attribute **EA** is read-write point used to enable or disable the ability to enable Override mode from a corresponding SBC-STAT.

Attribute **OM** displays whether or not an SBC-STAT is in an override state. Each bit set in F900;**OM** attribute will reflect the value of the corresponding bit from the local STAT interface (F900;**SO**) whenever access buttons (F900;**EA**) are disabled and auto mode (F900;**AM**) is enabled. If access buttons are enabled, **OM** will be controlled by the access buttons states (F900;**AB**); a value of 1 on an access button will initiate the STAT into override. Writes to these bits are permitted only when the corresponding bit in F900;**AM** is set to a value of 1 (manual mode).

The **AM** attribute is used to enable or disable manual writes to the F900;**OM** attribute. A bit with a value of 0 disables write access; where a bit with a value of 1 enables write access.

Schedule Summary, F900

Attribute	Description
ON	Schedule Summary Name specifies a user definable string that is used to help identify the channel or its function.
CV	Current Schedule Value indicates the current state of the controller. 0=Unoccupied 1=Warm-up 2=Occupied 3=Night setback
C1	Schedule 1 indicates the current state of Schedule 1. 0=Unoccupied 1=Warm-up 2=Occupied 3=Night setback
C2	Schedule 2 indicates the current state of Schedule 2. 0=Unoccupied 1=Warm-up 2=Occupied 3=Night setback
C3	Schedule 3 indicates the current state of Schedule 3. 0=Unoccupied 1=Warm-up 2=Occupied 3=Night setback
C4	Schedule 4 indicates the current state of Schedule 4. 0=Unoccupied 1=Warm-up 2=Occupied 3=Night setback
C5	Schedule 5 indicates the current state of Schedule 5. 0=Unoccupied 1=Warm-up 2=Occupied 3=Night setback
C6	Schedule 6 indicates the current state of Schedule 6. 0=Unoccupied 1=Warm-up 2=Occupied 3=Night setback
C7	Schedule 7 indicates the current state of Schedule 7. 0=Unoccupied 1=Warm-up 2=Occupied 3=Night setback

Attribute	Description
C8	Schedule 8 indicates the current state of Schedule 8. 0=Unoccupied 1=Warm-up 2=Occupied 3=Night setback
HO	Host Schedule Value specifies the desired host schedule override state. 0=Unoccupied 1=Warmup 2=Occupied 3=Night setback
HE	Enable Host Schedule specifies whether to use the schedule broadcast by the host. 0=No 1=Yes
DH	Holiday? specifies whether today is one of the holidays specified in H0-H9 .
H1	Programmed Holiday
H2	Programmed Holiday
H3	Programmed Holiday
H4	Programmed Holiday
H5	Programmed Holiday
H6	Programmed Holiday
H7	Programmed Holiday
H8	Programmed Holiday
H9	Programmed Holiday
IS	Inactive State the schedule mode that the controller will default to if there are no schedules which are currently active.
AS	Active Schedules lists the schedules which are currently active. bit #1=F901 bit #2=F902 bit #3=F903 bit #4=F904 bit #5=F905 bit #6=F906 bit #7=F907 bit #8=F908

Attribute	Description
SO	<p>Digital Stat Override Status displays the state of each STAT's local override flag.</p> <p>bit #0=SMARTStat 1 bit #1=SMARTStat 2 bit #2=SMARTStat 3 bit #3=SMARTStat 4 bit #4=SMARTStat 5 bit #5=SMARTStat 6 bit #6=SMARTStat 7 bit #7=SMARTStat 8 bit #8=SMARTStat 9 bit #9=SMARTStat 10 bit #10=SMARTStat 11 bit #11=SMARTStat 12</p>
AB	<p>Access Buttons States displays the state of the remote access control buttons.</p> <p>bit #0=Button 1 bit #1=Button 2 bit #2=Button 3 bit #3=Button 4 bit #4=Button 5 bit #5=Button 6 bit #6=Button 7 bit #7=Button 8 bit #8=Button 9 bit #9=Button 10 bit #10=Button 11 bit #11=Button 12</p>
EA	<p>Enable Access Buttons enables remote access button presses.</p> <p>bit #0=Enable Button 1 bit #1=Enable Button 2 bit #2=Enable Button 3 bit #3=Enable Button 4 bit #4=Enable Button 5 bit #5=Enable Button 6 bit #6=Enable Button 7 bit #7=Enable Button 8 bit #8=Enable Button 9 bit #9=Enable Button 10 bit #10=Enable Button 11 bit #11=Enable Button 12</p>
OM	<p>Override Map displays whether or not a STAT is in an override state.</p> <p>bit #0=Override 1 bit #1=Override 2 bit #2=Override 3 bit #3=Override 4 bit #4=Override 5 bit #5=Override 6 bit #6=Override 7 bit #7=Override 8 bit #8=Override 9 bit #9=Override 10 bit #10=Override 11 bit #11=Override 12</p>

Attribute	Description
AM	<p>Manual Control enables write commands to F900;OM.</p> <p>bit #0=Enable Button 1 bit #1=Enable Button 2 bit #2=Enable Button 3 bit #3=Enable Button 4 bit #4=Enable Button 5 bit #5=Enable Button 6 bit #6=Enable Button 7 bit #7=Enable Button 8 bit #8=Enable Button 9 bit #9=Enable Button 10 bit #10=Enable Button 11 bit #11=Enable Button 12</p>

3.16 SCHEDULES 1-8, F901-F908

The Schedule channels on the SBC-GPC3 are used to configure the eight different schedules available to control setpoints. Each of the Schedule channels has the following attributes: **ON**, **CV**, **OC**, **UN**, **NS**, **WO**, **AD**, and **AO**.

By configuring occupied times (**OC**), unoccupied times (**UN**), warm-up times (**WO**), night setback times (**NS**) and active days of the week (**AD**) the controller can be configured to adjust the heating and cooling setpoints based on the time of day and day of the week.

Attribute **ON** stores the name of the channel. This is a user definable string that can be used to help identify the channel or, for example, to identify what the schedule represents.

Each schedule has a **CV** attribute which displays the current state for schedule (0=unoccupied, 1= warm-up, 2=occupied, 3=night setback).

The SBC-GPC3 operates in one of four scheduled control states: occupied, unoccupied, warm-up and night setback.

Unoccupied mode, **CV**=0, is the period of time when people are not expected to be in the zone and temperature control is not as strict. During unoccupied mode, the SBC-GPC3 maintains cooling comfort levels at setup values and heating comfort levels at setback values. These setup and setback values are used to broaden the control range between the heating and cooling setpoints in order to provide less stringent control. The attributes used to define the offsets are located in the individual control loop channels, but the time of implementation is set in the individual schedules F901-F908. Unoccupied mode usually ends when night setback begins.

Warmup, **CV**=1, is the period of time before occupancy. During this period, the central air handler unit supplies warm air to the VAV boxes. Warmup provides special control action to bring the zone temperature to its desired setpoint for the occupied mode, based on the heating setpoint. The warmup period ends when occupied mode begins.

Occupied mode, **CV**=2, is the period of time when the zone is occupied by people and the SBC-GPC3 must maintain appropriate comfort levels in the zone. The heating and cooling setpoints define a desired zone temperature range. Occupied mode ends when unoccupied mode time begins.

Night setback, **CV**=3, is the period of time during unoccupied mode when the entire building is usually unoccupied and the air handler may be shut down. The SBC-GPC3 provides the option to set up and set back the night setback control temperature (as does the standard unoccupied mode), and when these offsets are reached or exceeded damper control of air flow resumes.

SBC-GPC3 schedules can be activated based on the values assigned to attributes in the Schedule channels F901-F908. When the current day of the week matches the setting of the active days (**AD**) attribute from one of the eight schedule channels, that channel's schedule becomes active. More than one schedule can be active at any given time, but they are prioritized so that the schedule with the highest mode priority dictates the control mode. Priority is determined in the following order:

- ▼ occupied (highest priority)
- ▼ warmup
- ▼ unoccupied
- ▼ night setback (lowest priority)

Control loops of the SBC-GPC3 may be configured to use the current schedule state of selected schedules to adjust setpoints. In occupied mode, for example, a setpoint value is used to determine when

a certain control action occurs. In unoccupied mode, a setup (or setback) amount is added to (or subtracted from, depending on its sign) the control loop setpoint, altering the point at which the control action occurs. In unoccupied mode, the control action is less stringent since fewer (if any) people are in the building during that time.

The schedule mode attributes define four windows for a schedule which is active for a set of days of the week. When the current day of the week matches one of the active schedule days the time of day determines which of the four available modes that will dictate control strategy.

The active days for the schedule are designated by the **AD** attribute. **AD** specifies a set of the eight possible days of the week (seven days plus holiday) during which the schedule will run in one of the four available modes at any given time of that particular active day.

Attributes **OC**, **UN**, **NS**, and **WO** specify the time of day when the controller's schedule state will change to Occupied, Unoccupied, Night Setback, and Warmup, respectively. The SBC-GPC3 will use these times for any days which are defined as active for the schedule.

Attribute **AD** is used to specify the active days for the schedule. The active days are those day for which the schedule will be applied. **AD** is a bitmap with bit #0 corresponding to Monday, bit #1 corresponding to Tuesday, etc. up to bit #6 which corresponds to Sunday. Bit #7 of **AD** corresponds to a Holiday. Setting a bit of **AD** equal to 1 makes the schedule active on the corresponding day.

Attribute **AO** is used to set the schedule state for the entire day. This can be used, for example, for holidays when you wish to keep the schedule unoccupied all day long. **AO** would also be used whenever you wished for the schedule to stay in a certain state around the clock without interruption. Figure 3-19 shows an examples of schedule.

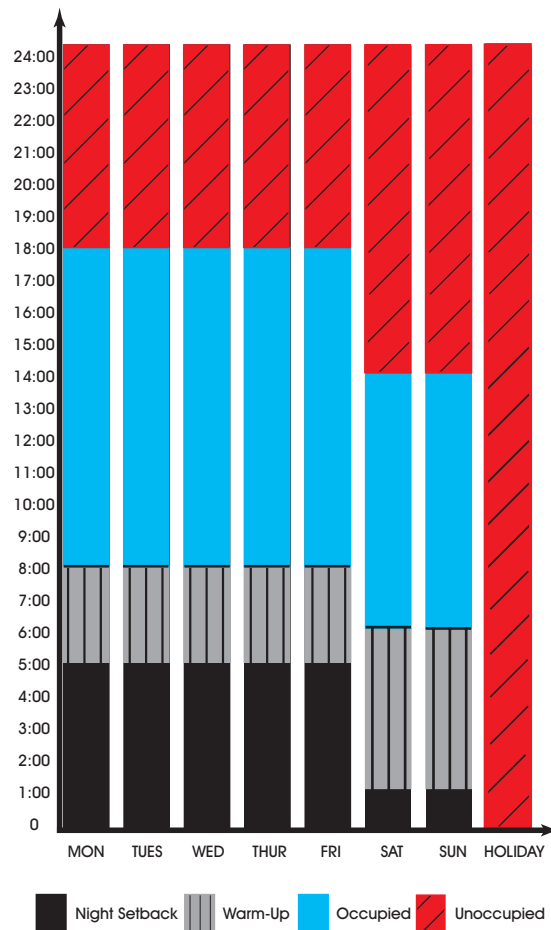

Figure 3-19: Example of schedule modes

To configure the schedule to work this way would require three schedules. The first schedule would control the weekdays and would have **AD** set for monday through friday. To set the times for the various schedule states, **OC** would be set to 8:00, **UN** to 18:00, **NS** to 0:00, and **WO** to 5:00. The second schedule would cover the weekends and would have **AD** set for saturday and sunday. for this schedule **OC** would be set to 6:00, **UN** to 14:00, **NS** to 0:00, and **WO** to 1:00. Finally, the third schedule would have **AD** set for holidays and **AO** set to "1=Unoccupied".

When the SBC-GPC3 is configured to receive schedules from a host controller, holiday schedules refer to the host system which defines the holidays in each month of the year. The SBC-GPC3 also has the ability to define holidays in F900;**HO**-F900;**H9**. If the SBC-GPC3 has bit 7 set for a currently active schedule, then the controller will follow that schedule when the holiday bit is sent from the host or if the current day corresponds to one of the holidays set in the SBC-GPC3. If the host broadcasts a holiday, and the SBC-GPC3 does not have a schedule with a holiday schedule, then no schedules will be active until the host clears the holiday.

All schedules are independent of each other. One or more schedules may be active when the rest are inactive.

Schedules 1-8, F901-F908

Attribute	Description
ON	Schedule Name specifies a user definable string that is used to help identify the channel or its function.
CV	Current Schedule Value indicates the current state of the schedule. 0=Unoccupied 1=Warm-up 2=Occupied 3=Night setback
OC	Time to go Occupied specifies the time when occupied mode should begin.
UN	Time to go Unoccupied specifies the time when unoccupied mode should begin.
NS	Time to go Night Setback specifies the time when night setback mode should begin.
WO	Time to go Warm-Up specifies the time when warm-up mode should begin.
AD	Active Days bitmap that specifies which days the schedule is active. Setting the appropriate bit to 1 indicates the schedule will be active on that day. bit #0=Monday bit #1=Tuesday bit #2=Wednesday bit #3=Thursday bit #4=Friday bit #5=Saturday bit #6=Sunday bit #7=Holiday
AO	All Day Override set the schedule state for the entire day. 0=None 1=Unoccupied 2=Warmup 3=Occupied 4=Night SETback

3.17 SCALES 1-4, F711-F714

The SBC-GPC3 is capable of scaling an input via a linear interpolation between two known points. Each Scale channel has the following attributes: **ON**, **CV**, **DT**, **IC**, **IA**, **X1**, **X2**, **Y1**, **Y2**.

The Scale channels interpolate along a line segment defined by the two points specified by **X1** and **Y1** and **X2** and **Y2**. This is shown in Figure 3-20.

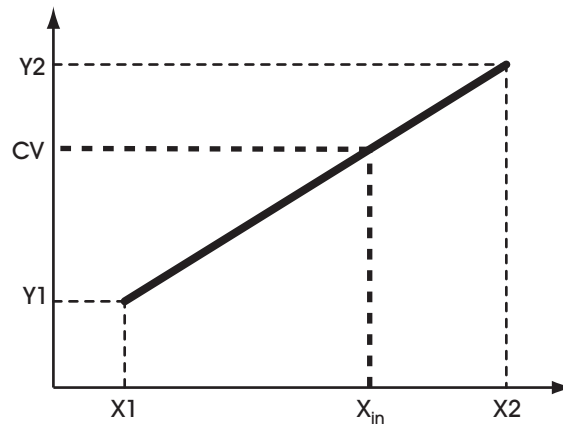

Figure 3-20: Using the Scale Channel to Interpolate a Value

Attribute **ON** stores the name of the channel. This is a user definable string that can be used to help identify the channel or, for example, to identify what the scaling is to be used for.

Attribute **CV** indicates the corresponding y-coordinate value corresponding to the x-coordinate specified in **IC** and **IA**.

Attribute **DT** indicates the datatype for the coordinates used to define the scaling function

The attributes **IC** and **IA** specify the channel and attribute of the value, between **X1** and **X2**, to be scaled. This value will be scaled and stored in **CV**.

NOTE

To clear **IC** and remove the association with its target channel, you must write a value of 0000 (four zeroes) to **IC**.

Attributes **X1**, **X2** and **Y1**, **Y2** indicate the x- and y-coordinate of the starting and ending points of the line segment used for scaling. Both x- and y-coordinate values are given in engineering units. The SBC-GPC3 will return a value equal to the y-coordinate on the line segment corresponding to the x-coordinate value from the input. If the input value is less than **X1**, then **CV** will be set to **Y1**. Similarly, if the input value is greater than **X2**, then **CV** will be set to **Y2**.

Scale 1-4, F711-F714

Attribute	Description
ON	Scale Name specifies a user definable string that is used to help identify the channel or its function.
CV	Current Value specifies the calculated scaled value.
DT	PUP Datatype for Values specifies the PUP datatype for the scale.
IC	Input Channel specifies the channel to be scaled.
IA	Input Attribute specifies the attribute associated with the channel specified in IC to be scaled.
X1	Input range X1 value specifies the minimum value of the input.
X2	Input range X2 value specifies the maximum value of the input.
Y1	Output range Y1 value specifies the minimum value of the scaled output.
Y2	Output range Y2 value specifies the maximum value of the scaled output.

3.18 PIECEWISE CURVES 1-2, F701-F702

The SBC-GPC3 can accommodate non-linear sensors by using built-in tables to define the response characteristics of the sensor. Each table requires 11 points to define 10 linear segments. These 10 segments approximate the response of the sensor. The controller will perform a linear interpolation to 'look up' values that lie along an individual segment much like the calculations performed by the Scale channels (F711-F714). Each of the Piecewise Curve channels contain attributes that define the operation and display its results. These attributes are **ON, DT, X1, X2, X3, X4, X5, X6, X7, X8, X9, XA, XB, Y1, Y2, Y3, Y4, Y5, Y6, Y7, Y8, Y9, YA** and **YB**.

Attribute **ON** stores the name of the channel. This is a user definable string that can be used to help identify the channel or the sensor type it is approximating.

Attribute **DT** indicates the datatype for the coordinates used to define the piecewise curve.

Attributes **X1** through **XB** represent the sensor readings for eleven chosen points on a sensor curve. These values must be in the same range as the chosen sensor type. So, for a 0-10 V input, **X1** through **XB** could take any value from 0 through 10. The values of **X1** through **XB** must be in increasing order (**X1** < **X2** < **X3** etc.).

Attributes **Y1** through **YB** are the Engineering Unit values (e.g., 70 degrees, 72 degrees, etc.), corresponding to the sensor readings entered into **X1** through **XB**. These values, coupled with the corresponding sensor readings, define the line segments which make up the piecewise curve.

To program a piecewise curve for a nonlinear sensor, you need to know the response characteristics of the sensor. These response characteristics are usually supplied by the manufacturer and may be in the form of a graph or table. Figure 3-21 shows an example of what a curve for a temperature sensor may look like. Once you have the response data, in either graph or table form, you must choose the points which define the line segments that approximate the response curve. When choosing the points to use, you can use fewer points in areas of the curve that are mostly linear and concentrate the points more to better approximate the more non-linear portions of the response.

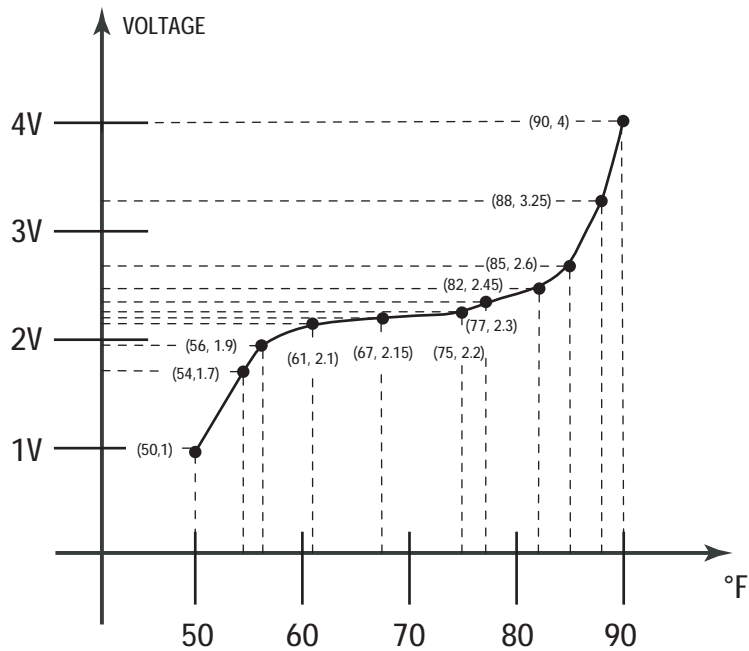

Figure 3-21: An Example of a Sensor Response Curve

From the graph, we can read the following values:

Table 3-15 : Sensor Response Points

Voltage	Temperature (°F)
1.00	50
1.70	54
1.90	56
2.10	61
2.15	67
2.20	75
2.30	77
2.45	82
2.60	85
3.25	88
4.00	90

To construct the piecewise curve, you would enter the values for the voltage into attributes **X1** Through **XB**. Similarly, the temperature values would be entered into **Y1** through **YB**. This gives the following assignments:

Table 3-16 : Assigning Sensor Response Points to the Piecewise Curve

	Voltage	Temperature (°F)	
X1 ⇐	1.00	50	⇒ Y1
X2 ⇐	1.70	54	⇒ Y2
X3 ⇐	1.90	56	⇒ Y3
X4 ⇐	2.10	61	⇒ Y4
X5 ⇐	2.15	67	⇒ Y5
X6 ⇐	2.20	75	⇒ Y6
X7 ⇐	2.30	77	⇒ Y7
X8 ⇐	2.45	82	⇒ Y8
X9 ⇐	2.60	85	⇒ Y9
XA ⇐	3.25	88	⇒ YA
XB ⇐	4.00	90	⇒ YB

Piecewise Curves 1-2, F701-F702

Attribute	Description
ON	Piecewise Curves Name specifies a user definable string that is used to help identify the channel or its function.
DT	PUP Datatype specifies the PUP datatype for the piecewise curve.
X1	Point 1's value in raw counts specifies the x coordinate of point 1.
X2	Point 2's value in raw counts specifies the x coordinate of point 2.
X3	Point 3's value in raw counts specifies the x coordinate of point 3.
X4	Point 4's value in raw counts specifies the x coordinate of point 4.
X5	Point 5's value in raw counts specifies the x coordinate of point 5.
X6	Point 6's value in raw counts specifies the x coordinate of point 6.
X7	Point 7's value in raw counts specifies the x coordinate of point 7.
X8	Point 8's value in raw counts specifies the x coordinate of point 8.
X9	Point 9's value in raw counts specifies the x coordinate of point 9.
XA	Point 10's value in raw counts specifies the x coordinate of point 10.
XB	Point 11's value in raw counts specifies the x coordinate of point 11.
Y1	Point 1's value in engineering units specifies the y coordinate of point 1.
Y2	Point 2's value in engineering units specifies the y coordinate of point 2.
Y3	Point 3's value in engineering units specifies the y coordinate of point 3.
Y4	Point 4's value in engineering units specifies the y coordinate of point 4.
Y5	Point 5's value in engineering units specifies the y coordinate of point 5.
Y6	Point 6's value in engineering units specifies the y coordinate of point 6.
Y7	Point 7's value in engineering units specifies the y coordinate of point 7.

Attribute	Description
Y8	Point 8's value in engineering units specifies the y coordinate of point 8.
Y9	Point 9's value in engineering units specifies the y coordinate of point 9.
YA	Point 10's value in engineering units specifies the y coordinate of point 10.
YB	Point 11's value in engineering units specifies the y coordinate of point 11.

3.19 MATH 1-2, F311-F312

The Math channels on the SBC-GPC3 are used to perform mathematical calculations using selectable input channels and the user’s choice of operator. The result can then be used as the measured variable input for any of the control loops within the controller. Each of the Math channels contain the following attributes: **ON**, **CV**, **DT**, **I1**, **A1**, **I2**, **A2** and **OP**.

Attribute **ON** stores the name of the channel. This is a user definable string that can be used to help identify the channel or the calculation it is performing.

Attribute **CV** is the current value of the performed calculation. It indicates the numeric result of applying the operand specified in **OP** to the values of the inputs attributes specified in **I1** and **A1** and **I2** and **A2** respectively. The data type of **CV** is determined by the value of **DT**.

Attribute **DT** is a value that represents the data type of the first operand in the specified mathematical operation. The data type of **CV** is set to be the same as the first operand.

Attributes **I1** and **A1** specify the input channel and attribute respectively. This becomes the first term in the mathematical calculation performed by the channel. Similarly, **I2** and **A2** represent the channel and attribute to be used as the second term in the calculation.

NOTE

To clear **I1**, **I2**, **I3**, or **I4** and remove the association with its target channel, you must write a value of 0000 (four zeroes).

Attribute **OP** specifies the operation to be performed on the channels selected in **I1**, **I2**, **A1** and **A2**. The values of **OP** and the corresponding operations are listed in Table 3-17.

Table 3-17 : Math Channel operation codes

OP	Operation
0	Disabled
1	Addition
2	Subtraction
3	Multiplication
4	Division

If **OP**=1, the channel adds the values selected in **I1**, **A1**, **I2** and **A2** (i.e. **CV**=**I1**;**A1**+**I2**;**A2**). **DT** will be used for the output value stored in **CV**.

If **OP**=2, the channel subtracts the value selected in **I2**, **A2** from the value selected in **I1** and **A1**(ie. **CV**=**I1**;**A1**-**I2**;**A2**). **DT** will be used for the output value stored in **CV**.

If **OP=3**, the channel multiplies the values selected in **I1**, **A1**, **I2** and **A2**(ie. **CV=I1;A1×I2;A2**). **DT** will be used for the output value stored in **CV**.

If **OP=4**, the channel divides the value selected in **I1**, **A1** by the value selected in **I2** and **A2**(ie. **CV=I1;A1÷I2;A2**). **DT** will be used for the output value stored in **CV**.

Math 1-2, F311-F312

Attribute	Description
ON	<p>Math Channel Name specifies a user definable string that is used to help identify the channel or its function.</p>
CV	<p>Current Value indicates the numeric result of applying the operand specified in OP to the inputs.</p>
DT	<p>PUP Data Type for Values specifies the PUP datatype for CV.</p>
I1	<p>Input channel 1 specifies the first input channel.</p>
A1	<p>Input Attribute 1 specifies the attribute associated with the first input channel.</p>
I2	<p>Input channel 2 specifies the second input channel.</p>
A2	<p>Input Attribute 2 specifies the attribute associated with the second input channel.</p>
OP	<p>Operation specifies the operation to be performed on the selected channels.</p> <p>0=Disabled 1=Addition 2=Subtraction 3=Multiplication 4=Division</p>

3.20 AVERAGES 1-3, F301-F303

The Averages channels on the SBC-GPC3 are used to calculate the minimum, the maximum and the average of selectable input channels. The result can then be used as the measured variable input elsewhere within the controller. Each of the Averages channels contain the following attributes: **ON**, **HV**, **AV**, **LV**, **DT**, **I1**, **A1**, **I2**, **A2**, **I3**, **A3**, **I4**, and **A4**.

Attribute **ON** stores the name of the channel. This is a user definable string that can be used to help identify the channel or the function it is programmed to perform.

Attribute **HV** is the highest value. It indicated the maximum value of the inputs specified in **I1;A1** through **I4;A4**.

Attribute **AV** is the Average Value. It displays the arithmetic mean of the inputs selected in **I1;A1** through **I4;A4**.

Attribute **LV** is the lowest value. It indicates the minimum value of the channels specified in **I1;A1** through **I4;A4**.

Attribute **DT** is a value that represents the data type that will be used for the minimum, maximum and average values stored in **LV**, **HV** and **AV** respectively.

Attributes **I1**, **I2**, **I3**, and **I4** specify the input channels for the first through fourth input respectively. This is the channel from which the input attribute will be chosen.

Attributes **A1**, **A2**, **A3**, and **A4** specify the input attribute for the first through fourth input respectively. This is the attribute which will be read from the input channels and used to determine the minimum, maximum and average value.

NOTE

To clear **I1**, **I2**, **I3**, or **I4** and remove the association with its target channel, you must write a value of 0000 (four zeroes).

Averages 1-3, F301-F303

Attribute	Description
ON	Averages Name specifies a user definable string that is used to help identify the channel or its function.
HV	High Value indicated the maximum value of the inputs specified in I1;A1 through I4;A4 .
AV	Average Value displays the arithmetic mean of the inputs selected in I1;A1 through I4;A4 .
LV	Low Value indicates the minimum value of the channels specified in I1;A1 through I4;A4 .
DT	PUP Datatype for Values specifies the PUP datatype for the min/max/avg values.
I1	Input channel 1 specifies the first input channel.
A1	Input Attribute 1 specifies the attribute associated with the first input channel.
I2	Input channel 2 specifies the second input channel.
A2	Input Attribute 2 specifies the attribute associated with the second input channel.
I3	Input channel 3 specifies the third input channel.
A3	Input Attribute 3 specifies the attribute associated with the third input channel.
I4	Input channel 4 specifies the fourth input channel.
A4	Input Attribute 4 specifies the attribute associated with the fourth input channel.

3.21 LOGIC 1-4, F321-F324

The Logic channels on the SBC-GPC3 are used to perform logical operations using selectable input channels and the user's choice of operator. For simple operations these channels can be used in place of SPL programs. Each of the Logic channels contain the following attributes: **ON, CV, DT, I1, A1, I2, A2, I3, A3, I4, A4, I5, A5, I6, A6, I7, A7, I8, A8** and **OP**.

Attribute **ON** stores the name of the channel. This is a user definable string that can be used to help identify the channel or the operation it is performing.

Attribute **CV** is the current value of the performed operation. The logic channel behaves as an 8-input logic gate. It indicates the result of applying the operand specified in **OP** to the values of the inputs attributes specified in **I1;A1** through **I8;A8**. It will apply the selected operation to every input specified and then output the result, i.e. a logical AND will only return "true" if all of the specified inputs are "true". If only two inputs are specified, the Logic channel will perform a simple logic operation on those inputs.

Attribute **DT** determines how certain attributes will display their values. Datatype codes determine the number of decimal places in the value, and whether it is signed (positive or negative) or unsigned. The default value for **DT** is 254 (unsigned 10 digit).

Attributes **I1** through **I8** and **A1** through **A8** specify the input channel and attributes, respectively, for the first through eighth inputs for the associated channel.

NOTE

To clear **I1, I2, I3, I4, I5, I6, I7, or I8** and remove the association with its target channel, you must write a value of 0000 (four zeroes).

Attribute **OP** specifies the logic operation to be performed on the channels selected. The operation available are listed in Table 3-18.

Table 3-18 : Logic Channel operation codes

OP	Operation
1	OR
2	AND
3	NOT (Input 1)
4	XOR

If **OP=1**, the channel will perform a logical OR on all of the selected channels (i.e. **I1:A1 OR I2:A2 OR I3:A3 OR I4:A4 OR I5:A5 OR I6:A6 OR I7:A7 OR I8:A8**). This operation will return "true" if any of the selected inputs are "true". If all of the inputs are "false", then **CV** will be set to "false".

If **OP=2**, the channel will perform a logical AND on all of the selected channels (i.e. **I1;A1 AND I2;A2 AND I3;A3 AND I4;A4 AND I5;A5 AND I6;A6 AND I7;A7 AND I8;A8**). This operation will return "true" only if all of the selected inputs are "true". If any of the inputs are "false", then **CV** will be set to "false".

If **OP=3**, the channel will perform a logical NOT. The NOT operator will only be applied to Input 1 input.

If **OP=4**, the channel will perform a logical XOR on all of the selected channels (i.e. **I1;A1 XOR I2;A2 XOR I3;A3 XOR I4;A4 XOR I5;A5 XOR I6;A6 XOR I7;A7 XOR I8;A8**). This operation will return "true" if an odd number of the selected inputs is "true". Otherwise, the result will be "false".

Logic 1-4, F321-F324

Attribute	Description
ON	Logic Channel Name specifies a user definable string that is used to help identify the channel or its function.
CV	Current Value indicates the result after the operand specified in OP has been applied to the inputs.
DT	PUP Datatype for Values
I1	Input channel 1 specifies the first input channel.
A1	Input Attribute 1 specifies the attribute associated with the first input channel.
I2	Input channel 2 specifies the second input channel.
A2	Input Attribute 2 specifies the attribute associated with the second input channel.
I3	Input channel 3 specifies the third input channel.
A3	Input Attribute 3 specifies the attribute associated with the third input channel.
I4	Input channel 4 specifies the fourth input channel.
A4	Input Attribute 4 specifies the attribute associated with the fourth input channel.
I5	Input channel 5 specifies the fifth input channel.
A5	Input Attribute 5 specifies the attribute associated with the fifth input channel.
I6	Input channel 6 specifies the sixth input channel.
A6	Input Attribute 6 specifies the attribute associated with the sixth input channel.
I7	Input channel 7 specifies the seventh input channel.
A7	Input Attribute 7 specifies the attribute associated with the seventh input channel.
I8	Input channel 8 specifies the eighth input channel.

Attribute	Description
A8	Input Attribute 8 specifies the attribute associated with the eighth input channel.
OP	Operation specifies the logic operation to be performed on the selected channels. 0=Disabled 1=OR 2=AND 3=NOT 4=XOR

3.22 PROGRAM SUMMARY, F200

The Program Summary channel provided an easy way to monitor the status of the SPL programs in the SBC-GPC3. The Program Summary Channel has the following attributes: **ON**, **\$1**, **\$2**, **\$3**, **\$4**, **\$5**, **\$6**, **\$7**, and **\$8**.

Attribute **ON** stores the name of the channel. This is a user definable string that can be used to help identify the channel or the program that is loaded.

Attributes **\$1** through **\$8** indicate the current state of the first through eighth SPL program in the SBC-GPC3 respectively.

A value of 0 indicates that the corresponding program is in the *stop* state. When the program is stopped, no instructions will execute and no outputs will be generated.

A value of 1 indicates that the corresponding program is in the *run* state. This means that the program is currently executing instructions.

A value of 2 indicates that the corresponding program is in the *unloaded* state. This means that there is currently no program loaded into the memory location

A value of 3 indicates that the corresponding program is in the *abort* state. If an executing program encounters an error, the program will abort. After the program aborts, an error code will be generated and stored in **\$E** in the corresponding Program channel to help explain the circumstance surrounding the abort state.

A value of 4 indicates that the corresponding program is in the *wait for time* state. This will be the state when the active program is executing an **MWAIT** or **SWAIT** command.

A value of 5 indicates that the corresponding program is in the *restart* state. If **\$x** (where x is 1-8) attribute is set to 5 from a stopped, unloaded or aborted state, the corresponding program is loaded into memory, if necessary) and the program then enters the run state **\$x=1**.

A value of 6 indicates that the program is in the *load* state. This setting has a similar effect to setting the value equal to 5. If necessary, the program is loaded and the program then enters the run state, **\$x=1**.

Program Summary, F200

Attribute	Description
ON	Program Summary Name specifies a user definable string that is used to help identify the channel or its function.
\$1	Program 1 Status indicates the current status of the resident SPL program number 1. 0=Stop 1=Run 2=Unloaded 3=Abort 4=Wait for Time 5=Restart 6=Load 7=Unload Request 8=Abort Request 9=Wait for Fetch
\$2	Program 2 Status indicates the current status of the resident SPL program number 2. 0=Stop 1=Run 2=Unloaded 3=Abort 4=Wait for Time 5=Restart 6=Load 7=Unload Request 8=Abort Request 9=Wait for Fetch
\$3	Program 3 Status indicates the current status of the resident SPL program number 3. 0=Stop 1=Run 2=Unloaded 3=Abort 4=Wait for Time 5=Restart 6=Load 7=Unload Request 8=Abort Request 9=Wait for Fetch
\$4	Program 4 Status indicates the current status of the resident SPL program number 4. 0=Stop 1=Run 2=Unloaded 3=Abort 4=Wait for Time 5=Restart 6=Load 7=Unload Request 8=Abort Request 9=Wait for Fetch

Attribute	Description
\$5	Program 5 Status indicates the current status of the resident SPL program number 6. 0=Stop 1=Run 2=Unloaded 3=Abort 4=Wait for Time 5=Restart 6=Load 7=Unload Request 8=Abort Request 9=Wait for Fetch
\$6	Program 6 Status indicates the current status of the resident SPL program number 6. 0=Stop 1=Run 2=Unloaded 3=Abort 4=Wait for Time 5=Restart 6=Load 7=Unload Request 8=Abort Request 9=Wait for Fetch
\$7	Program 7 Status indicates the current status of the resident SPL program number 7. 0=Stop 1=Run 2=Unloaded 3=Abort 4=Wait for Time 5=Restart 6=Load 7=Unload Request 8=Abort Request 9=Wait for Fetch
\$8	Program 8 Status indicates the current status of the resident SPL program number 8. 0=Stop 1=Run 2=Unloaded 3=Abort 4=Wait for Time 5=Restart 6=Load 7=Unload Request 8=Abort Request 9=Wait for Fetch

3.23 PROGRAMS 1-8, F201-F208

The Program channels contain attributes that are used to monitor and control the execution of the SPL programs that have been downloaded to the SBC-GPC3. These attributes are useful for debugging SPL programs as well as monitoring the progress of running programs. Each of the Program channels contain the following attributes: **ON**, **\$\$**, **\$D**, **\$E**, **\$\$S**, **\$C**, **\$W**, **\$1**, **%A**, **%B**, **%C**, **%D**, **%E**, **%F**, **%G**, **%H**, **%I**, **%J**, **%K**, **%L**, **%M**, **%N**, **%O** and **%P**.

Attribute **ON** stores the name of the channel. This is a user definable string that can be used to help identify the channel or the program that is loaded. **ON** will automatically be set to the name of the program which is loaded into the channel.

\$\$ is the current status attribute. It indicates the current state of the SPL program associated with the channel.

If **\$\$=0**, it indicates that the program is in the *stop* state. When the program is stopped, no instructions will execute and no outputs will be generated.

If **\$\$=1**, it indicates that the program is in the *run* state. This means that the program is currently executing instructions.

If **\$\$=2**, it indicates that the program is in the *unloaded* state. This means that there is currently no program loaded into the memory location associated with the channel.

If **\$\$=3**, it indicates that the program is in the *abort* state. If an executing program encounters an error, the program will abort. After the program aborts, an error code will be generated and stored in **\$E** to help explain the circumstance surrounding the abort state.

If **\$\$=4**, it indicates that the program is in the *wait for time* state. This will be the state when the active program is executing an **MWAIT** or **SWAIT** command.

If **\$\$=5**, it indicates that the program is in the *restart* state. If **\$\$** is set to 5 from a stopped, unloaded or aborted state, the program is loaded into memory, if necessary) and the program then enters the run state **\$\$=1**.

If **\$\$=6**, it indicates that the program is in the *load* state. this setting has a similar effect to setting **\$\$=5**. If necessary, the program is loaded and the program then enters the run state, **\$\$=1**.

Attribute **\$D** is the delay time remaining. It indicates the number of seconds remaining when an **SWAIT** or **MWAIT** statement is encountered in the SPL program.

Attribute **\$E** is the error code. When an SPL program aborts (**\$\$=3**), an error code is generated and placed in **\$E**. A complete list of the possible error code that can be generated is given in Appendix B: SPL Error Codes.

Attribute **\$\$S** indicates the section number. This is the value associated with the last executed **SECTION** statement in the SPL program. By strategically placing **SECTION** statements within the SPL program, it is possible to track the progress of the program by watching the value of **\$\$S**.

Attribute **\$C** is the program counter. It indicates the relative memory location of the next program statement to be executed. The value of **\$C** is given as a hexadecimal number.

Attribute **\$W** indicates how trappable errors are handled by the SPL program. When a trappable error occurs, the program can be configured to abort (**\$W=0**) or wait until the error no longer exists (**\$W=1**) based on whether the **ERRORABORT** and **ERRORWAIT** statements have been included in the SPL program code. For a list of trappable errors, see *Appendix B: SPL Error Codes*.

Attribute **\$1** enables single-step mode. **\$1** is used as a debugging tool for SPL programs, allowing the program to execute one line at a time. When single-step mode is enabled (**\$1=1**), the program will execute a single line and then stop. The program must then be manually restarted by setting **\$\$=1** in order to execute the next statement. Setting **\$1=0** returns the controller to normal operation.

Attributes **%A** through **%P** are program registers. Each one shows the current value of the associated register. Each register has a 32-bit value and a data type that is determined automatically based on the datatype of the value being written. The values of the registers can be changed by entering different values for each of these attributes.

Programs 1-8, F201-F208

Attribute	Description
ON	Program Name specifies a user definable string that is used to help identify the channel or its function.
\$\$	Current Status indicates the current status of the resident SPL program. 0=Stop 1=Run 2=Unloaded 3=Abort 4=Wait for Time 5=Restart 6=Load 7=Unload Request 8=Abort Request 9=Wait for Fetch
\$D	Delay Time Remaining specifies the number of seconds remaining when an SWAIT or MWAIT statement is encountered in the SPL program.
\$E	Error Code indicates the SPL error code that is returned when the program aborts.
\$S	Section Number indicates the current section number as determined by the SECTION statements in the SPL code.
\$C	Program Counter indicates the hexadecimal memory location of the next program statement to be executed.
\$W	Trappable Error Action specifies how the SPL program should handle trappable errors. 0=Abort on Error 1=Wait on Error
\$1	Enable Single-Step Mode? specifies whether the single-step, line by line debugging mode is enabled. 0=No 1=Yes
%A	Register A Value indicates the value of program register A.
%B	Register B Value indicates the value of program register B.
%C	Register C Value indicates the value of program register C.
%D	Register D Value indicates the value of program register A.
%E	Register E Value indicates the value of program register E.

Attribute	Description
%F	Register F Value indicates the value of program register F.
%G	Register G Value indicates the value of program register G.
%H	Register H Value indicates the value of program register H.
%I	Register I Value indicates the value of program register I.
%J	Register J Value indicates the value of program register J.
%K	Register K Value indicates the value of program register K.
%L	Register L Value indicates the value of program register L.
%M	Register M Value indicates the value of program register M.
%N	Register N Value indicates the value of program register N.
%O	Register O Value indicates the value of program register O.
%P	Register P Value indicates the value of program register P.

3.24 INPUT SELECT 1-4, F011-F014

The Input Select channels allow you to choose one of two user-defined channels based on a predetermined selection criteria. Each Input Select channel has the following properties: **ON**, **CV**, **DT**, **A1**, **A2**, **I1**, **I2**, **SC**, and **SA**.

The Input Select channel has a user definable name attribute (**ON**) that can be set to help identify the channel or the function it is performing.

The value of the attribute that is selected will be stored in **CV**.

Attribute **DT** determines how certain attributes will display their values. Datatype codes determine the number of decimal places in the value, and whether it is signed (positive or negative) or unsigned. **DT** will have the same datatype as the selected attribute.

To use the Input Select channel, two channels are specified using the **I1** and **A1** and **I2** and **A2** attributes. One of those two values will be selected based on the value of a selection criteria specified by the user.

The **SC** and **SA** attributes are used to pick the attribute that will be used as the selection criteria. If the chosen attribute has a value of 0, the attribute specified by **I1** and **A1** will be selected. If the chosen attribute has a value of 1, the attribute specified by **I2** and **A2** will be selected.

NOTE

To clear **I1**, **I2**, or **SC** and remove the association with its target channel, you must write a value of 0000 (four zeroes).

Input Select 1-4, F011-F014

Attribute	Description
ON	Input Select Name specifies a user definable string that is used to help identify the channel or its function.
CV	Current Value
DT	PUP Data Type for Values specifies the PUP datatype for CV .
I1	Input channel 1 specifies the first input channel.
A1	Input Attribute 1 specifies the attribute associated with the first input channel.
I2	Input channel 2 specifies the second input channel.
A2	Input Attribute 2 specifies the attribute associated with the second input channel.
SC	Selection Channel specifies the channel used as the selection criteria.
SA	Selection Attribute specifies the attribute associated with the selection channel used as the selection criteria.

3.25 BROADCAST 0-7, F000-F007

The Broadcast channels of the SBC-GPC3 allow it to send and receive values over the network. Each of the Broadcast channels contain the following attributes: **ON**, **BE**, **BZ**, **CV**, **DT**, **IC**, **IA** and **RB**. F002 has an additional attribute, **CE**, to enable outside air enthalpy calculation.

Attribute **ON** stores the name of the channel. This is a user definable string that can be used to help identify the channel or, for example, the value the channel is set to broadcast.

Attribute **BE** is the broadcast enable attribute. It specifies whether the controller should broadcast the value of **CV** over the network. If **BE**=1, the controller will broadcast the value of **CV**. If **BE**=0, no value will be broadcast.

Attribute **BZ** is the broadcast zone/global attribute. This attribute specifies whether the information broadcast will be sent to the entire network or just the units having the same zone number as the SBC-GPC3. If **BZ**=1, the information will be broadcast globally. If **BZ**=0, the value of **CV** will only be sent to controllers having the same zone number as the SBC-GPC3. In this case, only those controllers that are capable of receiving broadcasts on the same channel will be able to use the information.

Attribute **CV** indicates the current value of the channel and attribute specified on **IC** and **IA**. This is the value that will be broadcast by the associated channel.

Attribute **DT** is a value that represents the data type of **CV**. This will be the data type of the broadcast value.

Attributes **IC** and **IA** specify the channel and attribute respectively that is to be broadcast over the network.

NOTE

To clear **IC** and remove the association with its target channel, you must write a value of 0000 (four zeroes) to **IC**.

Attribute **RB** is the receive broadcast attribute. It specifies whether the controller should accept broadcasted values for **CV**. This attribute enables received values of **CV** to be directed to the channel and attribute specified in **IC** and **IA**. If **RB**=1, then the SBC-GPC3 will receive broadcast values for **CV**.

F002 can also be configured to calculate and broadcast the outside air enthalpy based on the values of one of the universal inputs, the zone temperature read from a STAT, the output of a PID loop, the output of one of the Average channels, or an SPL program attributes. F002;**CV** may also be calculated from F000;**CV** and F001;**CV**. The **CV** of F003 may also be calculated from the **CV** of F001 and F002.

NOTE

The outside air temperature and outside air humidity, as displayed in F000;**CV** and F001;**CV** respectively, must be configured to display a value, whether from a measured input or received from the PUP network as a broadcast, before the enthalpy can be calculated. The outside air temperature must be stored in F000;**CV** and the outside air humidity must be stored in F001;**CV**.

The enthalpy calculation is enabled by setting F002;**CE** to 1 after configuring the values of F000;**CV** and F001;**CV** as noted above.

F005 is intended to broadcast schedules exclusively. Because of this, F005;**CV** has a datatype (**DT**) of 254. **IA** for F006 is fixed as "**CV**" and cannot be changed. **IC** may only be set to on of the schedules (F901-F908), or the Schedule Summary channel (F900).

Broadcast 0-7, F000-F007

Attribute	Description
ON	Broadcast Name specifies a user definable string that is used to help identify the channel or its function.
CV	Current Value indicates the current value of the referenced channel specified in IC and IA .
DT	PUP Data Type for Values specifies the PUP datatype for CV .
IC	Input channel specifies the input channel to be broadcast.
IA	Input Attribute specifies the attribute associated with the channel specified in IC to be broadcast.
CE	Enthalpy Calculation Enable enabled the calculation and broadcast the outside air enthalpy (F002 only)
BE	Broadcast Enable specifies whether the controller should broadcast the value of CV over the network. 0=No 1=Yes
BZ	Broadcast Zone/Global specifies whether the controller's broadcasts are sent to the zone or broadcast globally. 0=Zone broadcast 1=Global broadcast
RB	Receive Broadcast? specifies that the controller should accept broadcasted values for the channel and attribute specified in IC and IA .

SECTION 4: SBC-STAT FEATURES

The digital SBC-STAT3 is equipped with a graphical display and gives the user the ability to modify and monitor certain parameters within the SBC-GPC3. The following sections describe the functions of the SBC-STATs and their displays, how to adjust setpoints using the SBC-STATs, and how to use the SBC-STAT3's menus when it is connected to an SBC-GPC3 Unitary Controller.

IN THIS SECTION

Temperature Display	4-4
Setpoint Adjustment Display	4-5
SBC-STAT2D	4-5
SBC-STAT3	4-5
Override Mode	4-8
SBC-STAT3 Menus	4-9
User Menu	4-10
Service Menu	4-11
Control Monitor	4-11
Temp Offset	4-13
Version	4-13
Reset	4-14
Install Menu	4-15
Control Monitor	4-15
LED Test	4-15
Properties	4-16
Reset	4-17

4.1 INTRODUCTION

The SBC-STAT-1D, SBC-STAT-2D, and SBC-STAT3 devices are convenient, stylish ways to monitor space temperature. The STAT-1D simply measures the temperature while providing no user interface. The STAT-2D, like the STAT-1D measures the temperature, but goes a step further providing a means for the user to adjust control setpoints via pushbuttons mounted on the front on the device. Finally, the STAT3 provides a complete graphical interface with a temperature display as well as the ability to monitor and change system variables via password protected menus.

NOTE

Only STAT-1Ds, STAT-2D, and STAT3s with firmware version 1.03 or newer may be used with the SBC-GPC1.

4.2 TEMPERATURE DISPLAY

When connected to an SBC-GPC3, the SBC-STAT3 displays the zone temperature, schedule mode, and the zone demand mode.

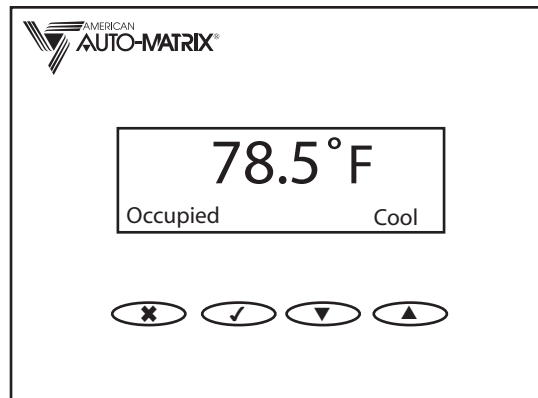

Figure 4-1: Room Temperature Display

You can control the way the STAT3 displays the temperature using the **DF** attribute in the Universal Input Channel to which the STAT has been assigned. Using the options in **DF**, you can choose the resolution of the display (degrees, or tenths of a degree) as well as whether or not to display the 'F' or 'C' denoting the units.

The schedule mode, displayed in the lower left corner, corresponds to the active schedule state of the controller. This will be the state with the highest priority from all of the active schedules. The possible schedule states are Occupied, Unoccupied, Night Setback, and Warmup.

The zone demand mode will indicate the mode called for by the Thermostatic Control loop for which the the STAT is being used as the input. The possible demand modes are Heat, Cool, and Vent.

4.3 SETPOINT ADJUSTMENT DISPLAY

If you press the ▲ or ▼ buttons on the STAT3, the setpoint adjustment display appears. This will be indicated by the LED blinking. The setpoint adjustment display allows you to modify the current temperature setpoint.

4.3.1 SBC-STAT2D

When the ▲ or ▼ button is first pressed, the LED will flash to indicate the current setpoint. The number of blinks corresponds to the number of increments that the setpoint has been adjusted. If the ▲ or ▼ button is pressed again within 15 seconds the setpoint will change by the user adjustment increment set using the **TM** attribute in the Universal Input channel to which the STAT has been assigned. The LED will flash red to indicate the new setpoint. The setpoint can be adjusted five increments on either side of zero, with zero being six (6) red flashes. This gives an adjustment range of +/- 5 x **TM**, with one (1) flash corresponding to and adjustment of -5 x **TM** and eleven (11) flashes corresponding to and adjustment of +5 x **TM**.

The LED on the SBC-STAT2D will also indicate the current schedule state of the controller. If the controller is currently in an Occupied state, the LED will be lit solid green. Warm up will be indicated by the LED blinking green while Night Setback and Unoccupied modes will be indicated by the LED flashing yellow periodically.

When the STAT is set to override using the User menu, the LED will blink red once every six seconds.

All of the patterns for the LED on the SBC-STAT2D are summarized in Table 4-1.

Table 4-1 SBC-STAT2D LED Patterns

Event	LED flash
Setpoint adjustment	coldest = 1 red flash
	= 2 red flashes
	= 3 red flashes
	= 4 red flashes
normal	= 5 red flashes
	= 6 red flashes
	= 7 red flashes
	= 8 red flashes
warmest	= 9 red flashes
	= 10 red flashes
	= 11 red flashes
Override mode	red flash every 6 seconds
Occupied mode	solid green
Warm up	flashing green
Night Setback	periodic yellow flash
Unoccupied mode	periodic yellow flash

4.3.2 SBC-STAT3

When the ▲ or ▼ button is first pressed, the current setpoint offset will be displayed on the graphical display as shown in Figure 4-2.

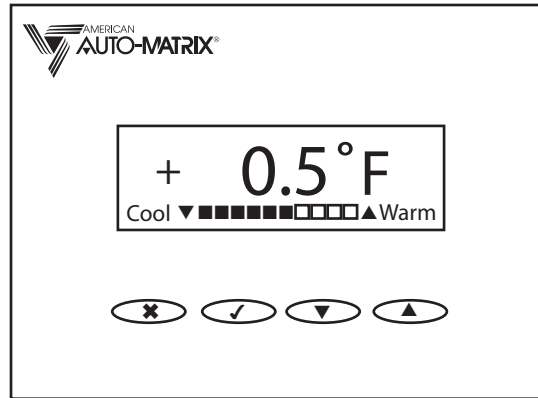

Figure 4-2: Setpoint Adjustment Display

If either the ▲ or ▼ buttons is pressed again within 15 seconds, the setpoint will move one increment in the direction of the button pressed. The increment is set using the **TM** attribute in the Universal Input channel to which the STAT has been assigned. The setpoint can be adjusted up or down by five increments, giving an adjustment range of +/- 5 x **TM**.

The LED on the SBC-STAT3 will also indicate the current schedule state of the controller. If the controller is currently in an Occupied state, the LED will be lit solid green. Warm up will be indicated by the LED blinking green while Night Setback and Unoccupied modes will be indicated by the LED flashing yellow periodically.

All of the patterns for the LED on the SBC-STAT3 are listed in Table 4-2.

Table 4-2 SBC-STAT3 LED Patterns

Event	LED flash
Setpoint adjustment	coldest = 1 red flash
	= 2 red flashes
	= 3 red flashes
	= 4 red flashes
	= 5 red flashes
	normal = 6 red flashes
	= 7 red flashes
	= 8 red flashes
	= 9 red flashes
	= 10 red flashes
	warmest = 11 red flashes
Occupied mode	solid green
Warm up	flashing green
Night Setback	periodic yellow flash
Unoccupied mode	periodic yellow flash

Table 4-2 SBC-STAT3 LED Patterns

Event	<i>LED flash</i>
Menus	solid yellow

4.4 OVERRIDE MODE

The Override mode allows building occupants to override the controller's programmed schedules, forcing it change the active schedule state to Occupied for a predetermined amount of time.

Override mode may only be entered if the active schedule state is warm-up, unoccupied, or night setback. Before the user can use the STAT to enter override mode, the following conditions must be met:

- ▼ The FE00;**SE** attribute must be set to "1=Enabled".
- ▼ The FE00;**ED** attribute must be set to a value greater than zero.
- ▼ The active schedule mode is warm-up, unoccupied, or night setback.

The SBC-STAT2-D will enter override mode when any key is pressed while in any schedule mode other than Occupied. Once in override mode, the LED will flash red every six seconds. To cancel override mode hold down the ▲ or ▼ button for five seconds or until the LED starts flashing. The LED will flash a minimum of ten times to confirm the cancellation.

The SBC-STAT3 enters override mode through the User Menu. To enter override mode, the user should enter the User menu by pressing the ✓ button, use the ▲ and ▼ keys to highlight **Override**, and then press the ✓ button. A "✓" icon will appear indicating that the controller's schedule has been overridden. When a number of minutes equal to the FE00;**ED** attribute has elapsed, override mode will be cancelled and the controller will return to its active schedule state.

4.5 SBC-STAT3 MENUS

There are three (3) menus in the SBC-STAT3, each of which provide different levels of monitoring and control. They are:

- ▼ User
- ▼ Install
- ▼ Service

When working in a menu, you press the ✓ button to initiate an action or enable/disable a function. After you have made the desired changes to the configuration, press the ✕ button to exit and return to the previous menu.

Options in the Service and Install menus allow you to navigate attributes to monitor or change their values. Selecting this option opens an Edit screen which allows you to change the value of the attribute. To change the value, use the ✓ button to move places to the right and the ▲ and ▼ buttons to change values. Once you have entered a desired value, press ✓ to highlight **set** and press ✓ once more to store the value and return to the previous menu. To exit the Edit screen without saving any changes, press ✕.

The User Menu, Service Menu, and Install Menu screen will be displayed for approximately thirty (30) seconds before returning to the temperature display screen and requiring you to re-enter a password (if required) to continue. Screens within those menus, such as the Control Monitor or Attributes screens, will remain active for approximately four (4) minutes before returning to the parent menu.

4.6 USER MENU

The User Menu is the most restrictive form of access allowed by the STAT. It allows end users to set the display preferences for the STAT as well as override the controllers built in schedule, if that feature is enabled in the SBC-GPC3. The User Menu can be reached by pressing the ✓ button while viewing the room temperature display. By default, no password will be required to enter the User menu. If you wish to require a password, the 4-digit password can be entered into the FE00;PU attribute. If PU is set back to 0, a password will no longer be required to access the User menu.

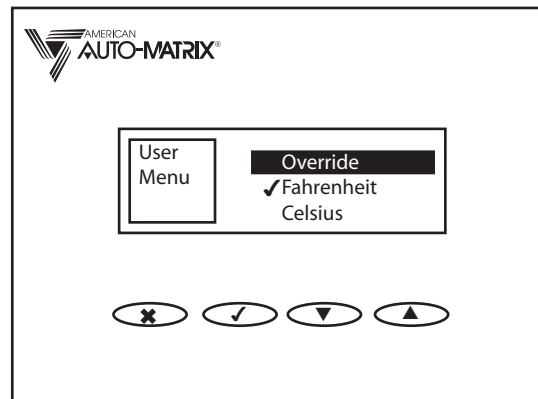

Figure 4-3: User Menu

From the User Menu the user can press the ▲ and ▼ buttons to highlight an entry. The available entries are **Override**, **Fahrenheit** and **Celsius**. Highlight then press the ✓ button to initiate an action or enable/disable an option.

Selecting the **Override** option puts the STAT in override mode and adjusts the controller's setpoints accordingly. For more information on the override mode, see *Section 4.4, Override Mode*.

Selecting the **Fahrenheit** or **Celsius** option will configure the STAT's display to read degrees Fahrenheit or degrees Celsius respective. Selecting one of these options will automatically deselect the other.

When you are finished configuring the setting in the User Menu, press the ✕ button to exit and return to the temperature display.

4.7 SERVICE MENU

The Service menu is intended to provide access to the building automation system for technicians and other authorized people to monitor system variables.

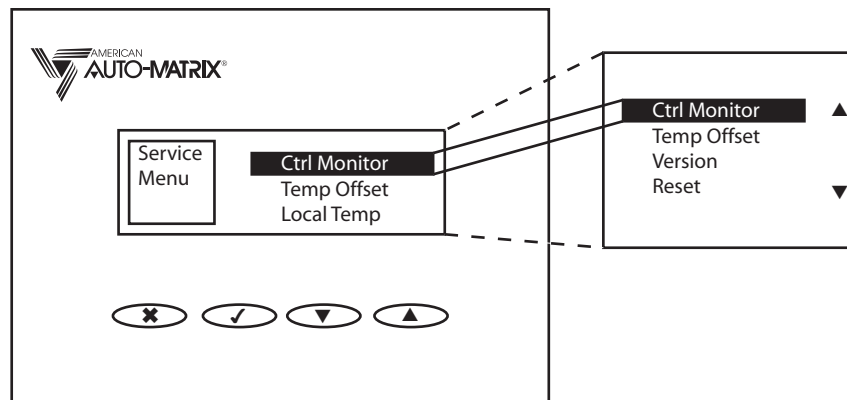

Figure 4-4 Service Menu

You can access the Service menu by pressing the **X** and **▼** buttons simultaneously. A prompt for a password will appear. The password is stored in the FE00;PS attribute and has a default value of 1100. If **PS** is set to 0, then you will not need to enter a password to access the Service menu.

To enter your four digit password, use the **▲** and **▼** buttons to increment or decrement the number selected in the display. The **✓** button is used to move the selected number one place to the right. Once you have entered the correct password press the **✓** button one more time to enter the Service Menu.

Through the Service Menu, users can:

- ▼ View Control Monitor functions
- ▼ Adjust the temperature offset for the STAT
- ▼ View version information for the controller and the STAT
- ▼ Reset the STAT and the controller

4.7.1 CONTROL MONITOR

The first option in the Service menu is the Control Monitor. It allows you to monitor the **CV** attribute associated with any of the Universal Input, Digital Input, Analog Output, or Digital Output channels. When you select the Control Monitor option from the Service Menu, the Control Monitor Menu, shown in Figure 4-5, will be displayed.

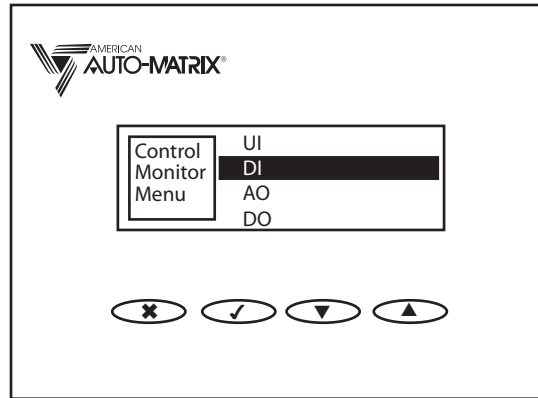

Figure 4-5 Control Monitor Menu

The Control Monitor Menu allows you to select the type of channel whose **CV** attribute you wish to monitor. You may choose Universal Inputs (UI), Digital Inputs (DI), Analog Outputs (AO), or Digital Outputs (DO). Use the ▲ and ▼ buttons to highlight the type of channel you wish to monitor and press the ✓ button to select that type. Once you have selected the type of channel to monitor, you will see the Control Monitor screen shown in Figure 4-6.

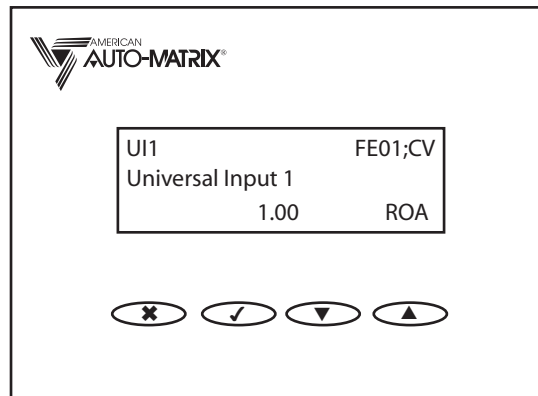

Figure 4-6 Control Monitor Screen

In the Control Monitor screen, the channel is shown in the upper left corner with the PUP channel number displayed in the upper right. The name given to the channel in the **ON** attribute is shown on the second line. The **CV** for the channel is shown in the middle of the bottom line.

In the lower right corner of the display are three characters used to display the reliability, override, and alarm status for the channel being viewed. The first position displays the reliability of the channel. A “-” is displayed if the channel is reliable, i.e. the channel’s **RE** is equal to 0. If the channel is unreliable, then an “R” will be displayed in the first position. Otherwise, a “-” will be displayed. The second position indicates the override status of the channel. If the channel’s **OI** attribute is set to “True”, then an “O” will be displayed in the second position. Otherwise, a “-” will be displayed. Finally, the third position indicates the alarm state of the channel. If the **AS** attribute for the selected channel indicates an alarm, then an “A” will

be displayed in the third position. If no alarms are indicated, a “-” will be displayed. If a space is shown instead of a “-” or a letter, that indicates that status is not applicable to the channel selected, for example Outputs do not have an **OI** attribute, so the second position would have blank space in it.

4.7.2 TEMP OFFSET

The Temp Offset option opens a screen, shown in Figure 4-7, which allows you to change the value of the temperature offset for the STAT. Use the up arrow button to toggle between a negative (-) and positive (+) sign. Use the ✓ button to move places to the right and the up and down arrows to change a value. Once you have entered a desired value, press ✓ to highlight **set** and press ✓ once more to store the value and return to the Service Menu. To exit the screen without saving any changes, press ✕.

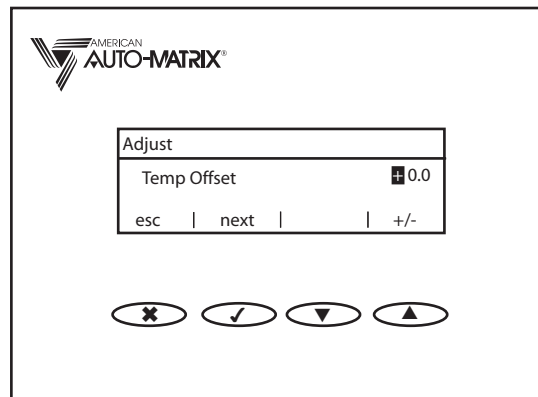

Figure 4-7: Temp Offset Screen

4.7.3 VERSION

The Version option displays information about the controller to which the STAT is connected. It displays:

- ▼ **S/N** - The serial number of the controller (FF00;**SN**)
- ▼ **Vers** - The version number of the controller firmware (FF00;**VE**)
- ▼ **Rel** -The software time stamp for the controller’s firmware (FF00;**SR**)
- ▼ **Type** - The firmware type number for the controller (FF00;**FT**)
- ▼ **Cont** - The controller type number for the controller (FF00;**CT**)
- ▼ **ID** - Unit ID (FF00;**SN**)
- ▼ **Stat** - The version number of the STAT firmware
- ▼ **GID** - The global identification number of the STAT

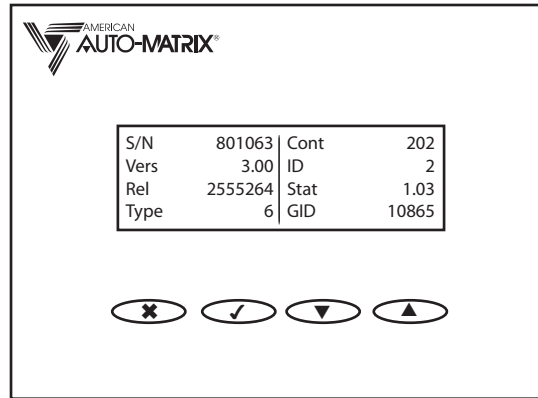

Figure 4-8: Version Screen

Pressing the ✕ button while viewing the Version option will return you to the Service menu.

4.7.4 RESET

Selecting this item restarts the SBC-STAT and the controller.

4.8 INSTALL MENU

The Install menu is intended for as a diagnostic and troubleshooting tool for those installing the building automation system. From within the Install Menu, users have the ability to monitor and change the value of attributes on the host controller.

You can access the Service menu by pressing the ✕ and ▲ buttons simultaneously. A prompt for a password will appear. The password is stored in the FE00;PI and has a default value of 3300. If PI is set to 0, then you will not need to enter a password to access the Service menu.

To enter your four digit password, use the ▲ and ▼ buttons to increment or decrement the number selected in the display. The ✓ button is used to move the selected number one place to the right. Once you have entered the correct password press the ✓ button one more time to enter the Service Menu.

Through the Install Menu, installers can:

- ▼ View Control Monitor functions
- ▼ Perform an LED Test
- ▼ Monitor/Edit attribute values of the NB controller
- ▼ Reset the SBC-STAT3 and NB controller

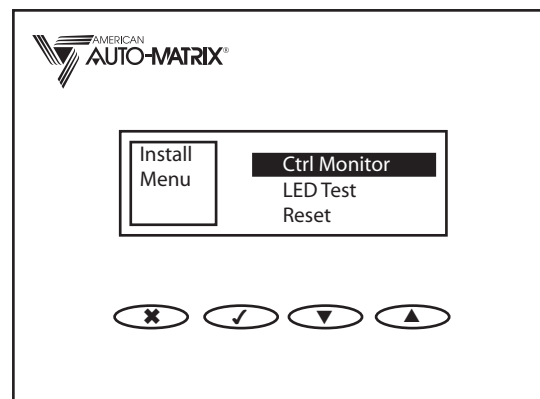

Figure 4-9: Install Menu

4.8.1 CONTROL MONITOR

The first menu option listed in the Install Menu is **Ctrl Monitor**. This option allows the monitoring of temperature control operation and is identical to the Control Monitor found in the Service Menu. For more on the functionality of the Control Monitor, see *Section 4.7.1, Control Monitor*.

4.8.2 LED TEST

The second option under the Install menu is LED Test. This allows the installer to test the LED by sequentially displaying the various LED modes. To display a given LED mode, first use the ▲ and ▼ buttons to highlight the LED Test option from the Install menu. Once highlighted, pressing the ✓ button will step sequentially through the LED modes. The available modes are:

- ▼ Flashing Green
- ▼ Green
- ▼ Flashing Yellow

- ▼ Yellow
- ▼ Flashing Red
- ▼ Red

When you reach the end of the sequence, the LED will return to the steady yellow which indicates you are in a menu.

4.8.3 PROPERTIES

The Properties Menu is the third option under the Install menu. It is used to monitor and modify attributes in the controller. When you select Properties from the Install menu, you will be presented with a screen like the one shown in Figure 4-10

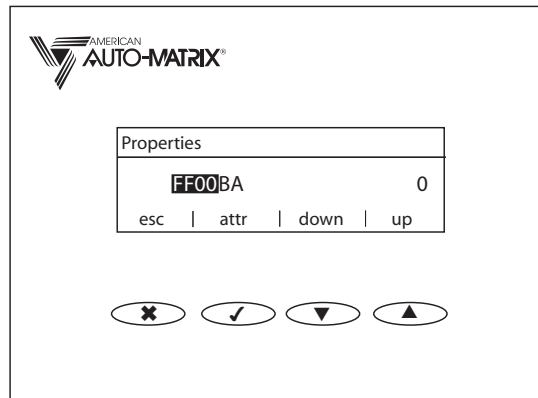

Figure 4-10 Properties Menu

This screen displays the four character channel name and two digit attribute name on the left hand side of the display and the value of the property on the right.

You can change the channel by pressing the ▼ button to go to the next channel and the ▲ button to go to the previous channel. If you are at the end of the list when you press the ▼ or the ▲ button, then the list will simply wrap around to the beginning or the end, depending on where in the list you were when you pressed the button.

Pressing the ✓ button will switch from channel to attribute in the display as shown in Figure 4-11.

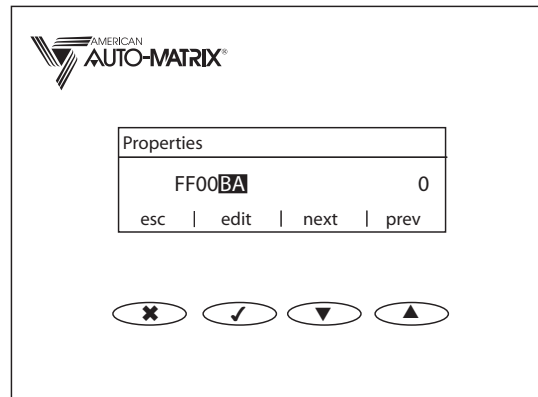

Figure 4-11 Selecting Attributes

Once the attribute is selected, you may use the ▼ and ▲ buttons, to navigate just as you would for channels. Pressing the ✓ button again will allow you to edit the value of the selected attribute if it is editable.

When you edit an attribute's value, you change the value one digit at a time. When you first press the ✓ button, the leftmost digit of the value will be highlighted. You can increase or decrease the value using the ▼ and ▲ buttons. Pressing the ✓ button again will highlight the next digit in the value. When you have the rightmost digit selected and press the ✓ button, you will see that the label for the ✓ button has changed to "set" and is highlighted. Pressing the ✓ button will now change the value of the attribute to the value you entered. At any time you may press the ✕ to return to the install menu without changing the value of the attribute.

4.8.4 RESET

This option restarts the controller and the SBC-STAT3.

SECTION 5: SPL SUPPORT

This section gives an overview of the SPL programming language and describes the features of SPL specific to the SBC-GPC3.

IN THIS SECTION

SPL: An Overview	5-3
What is SPL?	5-3
SPL and the SBC-GPC3	5-3
Creating an SPL Program for an SBC-GPC3	5-3
SPL Features Summary	5-5

5.1 SPL: AN OVERVIEW

5.1.1 WHAT IS SPL?

The SAGE Programming Language (SPL) is a powerful, rich control programming language. It is a BASIC-like programming language that has been adapted for real-time control applications. SPL's features include custom report generation, data logging, manipulation of database channels, floating point math support, trigonometric functions, mixed-mode math support, programmable attributes and registers, six-level expression nesting, and other features.

SPL allows you to create simple or complex, customized control programs using a rich set of features that support all types of real-time control and monitoring applications. The source code for these control programs are created offline on a personal computer using a standard text editor. The source code is translated into program code that is downloaded to the SBC-GPC3.

5.1.2 SPL AND THE SBC-GPC3

SPL can be used to create programs that can be used by the SBC-GPC3. A subset of all SPL features are available for creating an SPL program that will reside in a SBC-GPC3. A complete list of the SPL statements that are supported by the SBC-GPC3 are listed later in this section.

The SBC-GPC3 has a number of special purpose channels that can be used to control various inputs and outputs. There are also a number of channels specifically designed to efficiently accomplish tasks which would normally require SPL. These channels should be used whenever possible. The goal of any SPL program should be to write the least amount of code needed to accomplish the task at hand. This is done by utilizing as much of the built-in functionality of the SBC-GPC3 as possible.

For customized applications, those that cannot be accomplished using a combination of the channels and attributes in the controller, the SBC-GPC3 offers the ability to accept SPL programs into a portion of its memory. These RAM-resident, customized programs can be used to enhance existing control applications or to create new applications.

5.1.3 CREATING AN SPL PROGRAM FOR AN SBC-GPC3

There are several steps involved in creating an SPL program and downloading it to the SBC-GPC3. There are several tools that you should have at your disposal to accomplish this. These include:

- ▼ an ASCII text editor (such as WordPad)
- ▼ a Windows-based personal computer
- ▼ a connection to the SBC-GPC3 via an RS-485 converter
- ▼ SoloPro or other appropriate software tool

SPL program creation begins by entering source code into a source file. This source code is a logical and sequential list of SPL program statements (and compiler directives) that defines a desired process. This process may begin as a simple flowchart or pseudocode for the desired application.

Next, the source file is translated into program code that can be interpreted by the SBC-GPC3. This is called compiling and is accomplished using the SPL Editor, included with the SoloPro software package. The editor may either run as a stand-alone application or it can be called from SoloPro.

After the source code has been successfully compiled, the resulting program code can be used by the SBC-GPC3. The compiled program code is downloaded to the SBC-GPC3 using SoloPro or other appropriate software tool.

A brief summary of the SPL program development process is illustrated in Figure 5-1. For a complete discussion of writing SPL, refer to the SPL User Manual (refer to part number 1E-04-00-0082).

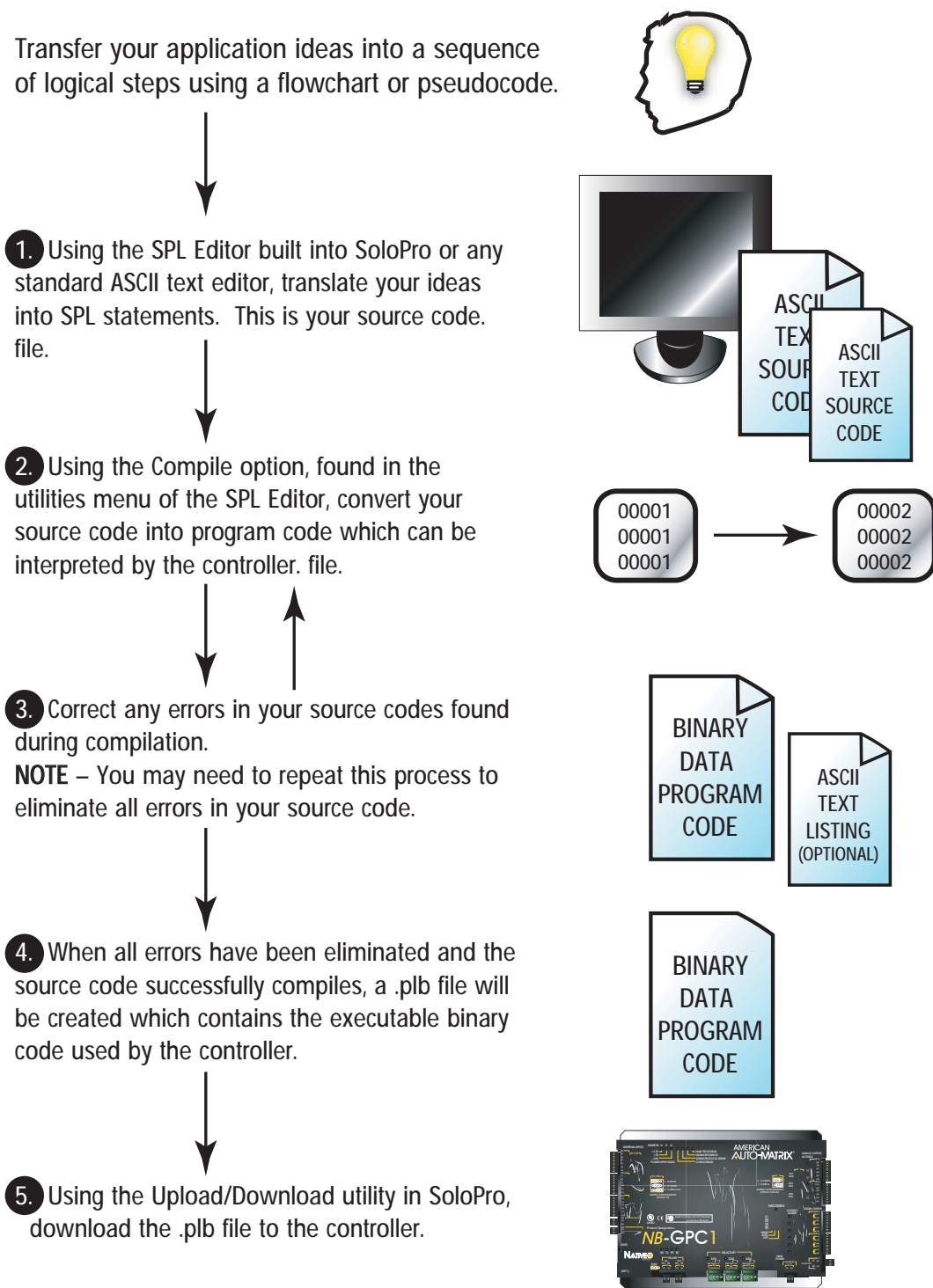

Figure 5-1 SPL Program Development Summary

5.2 SPL FEATURES SUMMARY

This section is intended to be a brief overview of the features (i.e., compiler directives, statements, terms/functions and operators) that are available for creating SPL programs to be downloaded into a SBC-GPC3. Refer to the SPL User Manual for more information about SPL and unitary controllers.

When you write your SPL program for the SBC-GPC3, you must include a special SPL compiler directive at the beginning of the source code. The #GPC compiler directive should appear at the beginning (typically the first line) of any SPL program that has the SBC-GPC3 as its target platform. This alerts the SPL compiler to accept only those SPL statements and features that are supported by the SBC-GPC3.

The #ONESEC and #ENDONESEC compiler directives may also be used in any SPL program that has the SBC-GPC3 as its target platform. These directives are used to define the portion of the program that is the once-per-second subroutine (that portion of code which is enclosed by the two directives). The once-per-second routine is executed one time every second to provide a precise time-based mechanism for executing portions of code at regular intervals. This routine is called automatically by the SBC-GPC3 and cannot be called from the main program. The #ENDONESEC compiler directives may be eliminated if the once-per-second routine extends to the end of the program logic block (PLB).

Other compiler directives (not specific to SBC-GPC3) are listed in Table 5-1.

Table 5-1 lists the SPL statements that are supported by the SBC-GPC3. A brief description of each statement is included. Table 5-2 lists the SPL terms and functions that are supported by the SBC-GPC3. A brief description of each is included. Table 5-3 lists the SPL expression operators that are supported by the SBC-GPC3. A brief description of each is included.

For a complete description of SPL and the utilities used to write and compile SPL programs, refer to the SPL User Manual.

Table 5-1 Program Statements

Format	Description
variable=expression	assignment statement
ALARM <i>classexpr</i>, "formatstring", x,x,x...x,x,x	generates an alarm
ATTR progattr,datatype	declare program attribute
CALL <i>PLBname</i>	go to external subprogram's logic block then load, execute and possibly unload it
DATA <i>v1,v2,v3,v4...</i>	initialize the individual elements of a ram-based table
DREF <i>unit,channel;attr</i>	adds entries to the attribute table at the end of the PLB
ERRORABORT	trap condition - abort on errors
ERRORWAIT	trap condition - wait until no error
GOSUB <i>label</i>	go to internal subroutine
GOTO <i>label</i>	unconditional branch
IF <i>expression</i> THEN <i>label</i>	conditional branch if <i>expression</i> is true
IF <i>expression</i> THEN <i>label1</i> ELSE <i>label2</i>	conditional branches to <i>label1</i> if <i>expression</i> is true or to <i>label2</i> if <i>expression</i> is false
LOOP <i>register,label</i>	iteration control
MWAIT <i>expression</i>	wait a certain amount of minutes
NOP	no operation used for debugging

Table 5-1 Program Statements

ON expression GOTO label0,label1...labeln	indexed conditional branches
ONERROR label	trap condition - branch if error occurs
PRINT <i>portexpr,classexpr,"formatstring",x,x,x...x,x,x</i>	print information to a port
RETURN	return from a subroutine
SECTION number	section marker used for debugging
STOP	halt execution of this program
STOP progname	halt execution of specified program
SWAIT expression	wait a certain amount of seconds
WAIT (expression)	wait until an expression is true, then go on

Table 5-2 SPL Functions

Function	Description
ABS(x)	Absolute value
ARCTAN(x)	Arctangent value
BETWEEN(tx1,tx2)	Between two times
COS(x)	Cosine value
EXP(x)	e^x
FIX(fx,ix)	Convert float to fixed
FLOAT(ix)	Convert integer to float
INT(x)	Convert x to integer
LN(x)	Natural logarithm
LOG(x)	Logarithm
MAX(x1,x2,...x8)	Maximum value from list
MEAN(x1,x2,...x8)	Mean value from list
MIN(x1,x2,...x8)	Minimum value from list
RETYPE(x1,x2)	Convert to a specified datatype
ROUND(x)	Round off
SIN(x)	Sine value
SQRT(x)	Square root
TAN(x)	Tangent value
TODAY(ix)	Compare today's day of week

Table 5-3 Expression Operators

Operator	Description
-	Unary negation
NOT	Unary ones complement
**	Exponential
*	Multiplication
/	Division
MOD	Remainder after division
+	Addition
-	Subtraction
==	Equality
<>	Inequality
>	Greater than
>=	Greater than or equal
<	Less than
<=	Less than or equal
AND	Bitwise And
OR	Bitwise Or
XOR	Bitwise Exclusive-Or
SHL	Bitwise Shift Left
SHR	Bitwise Shift Right

APPENDIX A: CHANNEL ATTRIBUTES

The following tables contain a list of Public Unitary Protocol (PUP) attribute and channel assignments for the GPC. Each attribute is given with its PUP channel assignment, PUP data type, access code, where it is stored and a brief description of its function.

IN THIS SECTION

System Channel, FF00	A-3
StatBus Channels 1-4, FF01-FF04	A-7
Universal Input Summary, FE00	A-8
Universal Inputs 1-24, FE01-FE18	A-11
Digital Input Summary, FE30	A-14
Digital Inputs 1-8, FE31-FE38	A-16
Occupancy Detector, FC01	A-19
Analog Output Summary, FD00	A-20
Analog Outputs 1-12, FD01-FD0C	A-21
Digital Output Summary, FB00	A-23
Digital Outputs 1-12, FB01-FB0C	A-26
PID Control 1-12, FA01-FA0C	A-28
Thermostatic Control 1-12, FA11-FA1C	A-31
Floating Point Control 1-2, FA21-FA22	A-33
Schedule Summary, F900	A-36
Schedules 1-8, F901-F908	A-39
Scales 1-4, F711-F714	A-40
Piecewise Curves 1-2, F701-F702	A-41
Math 1-2, F311-F312	A-43
Averages 1-3, F301-F303	A-44
Logic 1-4, F321-F324	A-45
Program Summary, F200	A-47
Programs 1-8, F201-F208	A-49
Input Select 1-4, F011-F014	A-51
Broadcast 0, F000	A-52
Broadcast 0, F000	A-52
Broadcast 2, F002	A-54
Broadcast 3, F003	A-55
Broadcast 4, F004	A-56
Broadcast 5, F005	A-57
Broadcast 6, F006	A-58
Broadcast 7, F007	A-59

SYSTEM CHANNEL, FF00

Attribute	Data Type	Access	Storage	Default	Description
BA	FE	RW	NRAM	0	Broadcast Alarms? specifies whether alarms are to be broadcast over the network 0=No 1=Yes
BF	FE	RW	NRAM	0	Broadcast Fire? specifies whether the "change to fire mode" command should be broadcast 0=No 1=Yes
BS	FE	RW	NRAM	0	Broadcast Sync Time? specifies whether to broadcast time synchronization information 0=No 1=Yes
BT	FE	RW	NRAM	255	Broadcast Time Interval specifies the time (in minutes) between network broadcasts
CF	FE	RW	NRAM	0	Communication Failure Timeout specifies the amount of time, in seconds, that the controller will wait to be polled before entering a communication fault state.
CM	FE	RO	RAM	255	Manufacturer indicates the factory-set manufacturer number for the controller. (CM for American Auto-Matrix controllers is always 255)
CP	FE	RW	NRAM	0	Communication Speed the rate at which the controller communicates. 0=9600 6=38400 7=19200 8=115.2k 9=57.6k
CR	FE	RW	NRAM	0	Configure Remote I/O specifies options for the configuration of remote I/O device located on the STATbus. 0=Normal 1=GPC to bus 2=Edit I/O GIDs 3=GPC from bus
CT	FE	RO	RAM	105	Controller Type factory-set controller type number for the controller. CT for the SBC-GPC is 105.
DA	FE	RO	RAM		Day of Week the current day of the week 0=Monday 1=Tuesday 2=Wednesday 3=Thursday 4=Friday 5=Saturday 6=Sunday

Attribute	Data Type	Access	Storage	Default	Description
DE	FE	RW	RAM	0	Default Enable used to return all attributes in the controller to their default values. 0=Normal operation 197=set attributes to their default values.
DS	FE	RO	NRAM	0	Daylight Savings Status specifies whether the current date is included in daylight savings time. 0=No 1=Yes
DT	E4	RW	RAM		Current Date the current date displayed as MM/DD/YYYY
EM	FE	RW	NRAM	0	Engineering Units specifies the units to be used when returning values 0=English 1=Metric
ER	FE	RW	NRAM	0	Token Recovery? If Token Error Recovery is enabled and a token is lost, Full Administrator will detect the condition and initiate a new token. 0=Disabled 1=Enabled
ET	E6	RW	NRAM	00:00	Daylight Saving End Time specifies the time at which daylight saving time ends.
FA	E9	RO	NRAM		Faults Detected a bitmap indicating the current fault conditions. bit 0=Fire bit 1=Emergency bit 54Communications failure
FC	FE	RO	NRAM	0	Flash update count indicates the number of times the controller has been flashed.
FT	FE	RO	RAM		Firmware Type indicates which firmware is installed on the controller 7=GPC1 8=GPC2 9=GPC3
ID	FE	RW	NRAM		Unit Number (ID) specifies the controller's identification number. The value of ID defaults to the last four digits of the unit's serial number.
ND	FE	RW	NRAM	0	Daylight Saving End Day specifies the day on which daylight savings time ends 0 = None 1 = First Sunday 2 = First Friday 3 = Second Saturday 4 = Third Sunday 5 = Third Saturday 6 = Last Sunday 7 = Last Thursday 8 = Last Friday

Attribute	Data Type	Access	Storage	Default	Description
NM	FE	RW	NRAM	0	<p>Daylight Saving End Month specifies the month in which daylight savings time ends</p> <p>0 = None 1 = January 2 = February 3 = March, 4 = April 5 = May 6 = June 7 = July 8 = August 9 = September 10 = October 11 = November 12 = December</p>
ON	DF	RW	NRAM	"SBC-GPC3"	<p>GPC Name specifies a user definable string that is used to help identify the channel or its function.</p>
OS	FA	RO	RAM		<p>Kernel Version indicates the version number of the kernel.</p>
PD	FE	RW	NRAM	15	<p>Power-Up Delay time delay (in seconds) that must elapse after the controller is reset before it begins control and alarming functions.</p> <p>5-6000=# of seconds</p>
PS	FE	RW	NRAM	0	<p>Power-up state schedule state that the controller will operate in when it is first powered up or after power is restored following a power failure.</p> <p>0=unoccupied 1=warmup 2=occupied 3=night setback</p>
RD	FE	RW	NRAM	0	<p>Daylight Savings Start Day specifies the day on which daylight saving time begins</p> <p>0 = None 1 = First Sunday 2 = First Friday 3 = Second Saturday 4 = Third Sunday 5 = Third Saturday 6 = Last Sunday 7 = Last Thursday 8 = Last Friday</p>
RM	FE	RW	NRAM	0	<p>Daylight Savings Start Month specifies the month in which daylight savings time begins</p> <p>0 = None 1 = January 2 = February 3 = March, 4 = April 5 = May 6 = June 7 = July 8 = August 9 = September 10 = October 11 = November 12 = December</p>

Attribute	Data Type	Access	Storage	Default	Description
RS	FE	RW	RAM	No	Reset the Controller? used to reset the controller. Setting RS to 1 resets the controller. 0=No 1=Yes
SN	FE	RO	NRAM		Serial Number the factory-set serial number.
SR	FE	RO	RAM		Flash Release Code the release code of the firmware currently flashed on the controller, used primarily for technical support purposes.
ST	E6	RW	NRAM	00:00	Daylight Saving Start Time specifies the time at which daylight savings time begins.
TF	FE	RO	NRAM	0	Time to Remain in Fire Mode The time (in minutes) that the controller will remain in fire mode.
TM	E6	RW	RAM		Current Time indicates the current time in the form HH:MM.
TP	FE	RW	NRAM	0	Token Passing Type defines the mode for token passing. 0=Irres 1=Full Admin
U1	FE	RW	NRAM	65535	Peer Unit Number specifies the unit number (ID) for the first peer unit on the network. ID is set to 65,535 if there is no peer.
U2	FE	RW	NRAM	65535	Peer Unit Number specifies the unit number (ID) for the second peer unit on the network. ID is set to 65,535 if there is no peer.
U3	FE	RW	NRAM	65535	Peer Unit Number specifies the unit number (ID) for the third peer unit on the network. ID is set to 65,535 if there is no peer.
U4	FE	RW	NRAM	65535	Peer Unit Number specifies the unit number (ID) for the fourth peer unit on the network. ID is set to 65,535 if there is no peer.
UP	FE	RO	NRAM		Flash update count indicates the number of times the controller has been flashed.
VE	FA	RO	RAM		Firmware Version contains the version of the controller's firmware.
ZN	FE	RW	NRAM	0	Zone Number a number (from 0 to 65,535) used to group controllers so that they may be controlled together.

STATBUS CHANNELS 1-4, FF01-FF04

Attribute	Data Type	Access	Storage	Default	Description
BS	FE	RO	RAM	0	Bus Status indicates the status of the SMARTStat Bus. 0=Ok 1=Needs configured 2=Error
CD	FE	RW	RAM	0	Configure Device (GID) used to specify a specific STATbus device that will be used with CF.
CF	FE	RW	RAM	0	Configure Function 0=Disabled 1=Blink LED
G1	FE	RW	NRAM	0	GID Device 1 indicates the global identification number of device 1.
G2	FE	RW	NRAM	0	GID Device 2 indicates the global identification number of device 2.
G3	FE	RW	NRAM	0	GID Device 3 indicates the global identification number of device 3.
G4	FE	RW	NRAM	0	GID Device 4 indicates the global identification number of device 4.
G5	FE	RW	NRAM	0	GID Device 5 indicates the global identification number of device 5.
G6	FE	RW	NRAM	0	GID Device 6 indicates the global identification number of device 6.
G7	FE	RW	NRAM	0	GID Device 7 indicates the global identification number of device 7.
G8	FE	RW	NRAM	0	GID Device 8 indicates the global identification number of device 8.
G9	FE	RW	NRAM	0	GID Device 9 indicates the global identification number of device 9.
GA	FE	RW	NRAM	0	GID Device 10 indicates the global identification number of device 10.
GB	FE	RW	NRAM	0	GID Device 11 indicates the global identification number of device 11.
GC	FE	RW	NRAM	0	GID Device 12 indicates the global identification number of device 12.
GD	FE	RW	NRAM	0	GID Device 13 indicates the global identification number of device 13.
ON	DF	RW	NRAM	"STATbus n" where n=1 to 3	StatBus Name specifies a user definable string that is used to help identify the channel or its function.
SM	FE	RO	RAM	0	Status Map 0=reserved 1=unconfigured 2=duplicate

UNIVERSAL INPUT SUMMARY, FE00

Attribute	Data Type	Access	Storage	Default	Description
AT	FE	RW	NRAM	0	Alarm Limit setup/setback time delay the time (in minutes) that must elapse after transitions from occupied to unoccupied or from unoccupied to occupied before alarm limits return to their previous (pre-setup/setback) values.
ED	FE	RW	NRAM	0	Extended Occupancy Duration specifies the time, in minutes, occupancy is extended when the stat indicates an override
IP	E9	RW	NRAM	0	Input Polarities specifies how the controller represents the input internally. 0=Normal polarity. Low Voltage is displayed as CV=0 and High Voltage is displayed as CV=1 . 1=Reverse polarity. Low Voltage is displayed as CV=1 and High Voltage is displayed as CV=0 . IP is a bitmap with bit 1 corresponding to UI1, bit 2=UI2, etc. up to bit 24=UI24.
LP	E9	RW	NRAM	0	Interlock Polarities indicates the individual interlock polarity states for each UI. 0=Normal 1=Reverse LP is a bitmap with bit 1 corresponding to UI1, bit 2=UI2, etc. up to bit 24=UI24.
OI	E9	RW	NRAM	0	Overridden Inputs allows the current value of the corresponding input, V1 through VO, to be overridden. 0=Normal 1=Override OI is a bitmap with bit 1 corresponding to UI1, bit 2=UI2, etc. up to bit 24=UI24.
ON	DF	RW	NRAM	"Universal Input Summary"	Universal Inputs Summary Name specifies a user definable string that is used to help identify the channel or its function.
PI	FE	RW	NRAM	0	Installer P.I.N. specifies the P.I.N. code used to enter the Installer menu.
PS	FE	RW	NRAM	1100	Service P.I.N. specifies the P.I.N. code used to enter the Service menu.
PU	FE	RW	NRAM	0	User P.I.N. specifies the P.I.N. code used to enter the User menu.
RE	E9	RO	RAM		Inputs with Unreliable Channels indicates whether the reading from the corresponding input is considered reliable. 0=Reliable 1=Unreliable RE is a bitmap with bit 1 corresponding to UI1, bit 2=UI2, etc. up to bit 24=UI24.
V1	FE	RW	RAM		Current Measured Input 1 Value indicates the current measured value of input 1.

Attribute	Data Type	Access	Storage	Default	Description
V2	FE	RW	RAM		Current Measured Input 2 Value indicates the current measured value of input 2.
V3	FE	RW	RAM		Current Measured Input 3 Value indicates the current measured value of input 3.
V4	FE	RW	RAM		Current Measured Input 4 Value indicates the current measured value of input 4.
V5	FE	RW	RAM		Current Measured Input 5 Value indicates the current measured value of input 5.
V6	FE	RW	RAM		Current Measured Input 6 Value indicates the current measured value of input 6.
V7	FE	RW	RAM		Current Measured Input 7 Value indicates the current measured value of input 7.
V8	FE	RW	RAM		Current Measured Input 8 Value indicates the current measured value of input 8.
V9	FE	RW	RAM		Current Measured Input 9 Value indicates the current measured value of input 9.
VA	FE	RW	RAM		Current Measured Input 10 Value indicates the current measured value of input 10.
VB	FE	RW	RAM		Current Measured Input 11 Value indicates the current measured value of input 11.
VC	FE	RW	RAM		Current Measured Input 12 Value indicates the current measured value of input 12.
VD	FE	RW	RAM		Current Measured Input 13 Value indicates the current measured value of input 13.
VE	FE	RW	RAM		Current Measured Input 14 Value indicates the current measured value of input 14.
VF	FE	RW	RAM		Current Measured Input 15 Value indicates the current measured value of input 15.
VG	FE	RW	RAM		Current Measured Input 16 Value indicates the current measured value of input 16.
VH	FE	RW	RAM		Current Measured Input 17 Value indicates the current measured value of input 17.
VI	FE	RW	RAM		Current Measured Input 18 Value indicates the current measured value of input 18.
VJ	FE	RW	RAM		Current Measured Input 19 Value indicates the current measured value of input 19.
VK	FE	RW	RAM		Current Measured Input 20 Value indicates the current measured value of input 20.
VL	FE	RW	RAM		Current Measured Input 21 Value indicates the current measured value of input 21.
VM	FE	RW	RAM		Current Measured Input 22 Value indicates the current measured value of input 22.

Attribute	Data Type	Access	Storage	Default	Description
VN	FE	RW	RAM		Current Measured Input 23 Value indicates the current measured value of input 23.
VO	FE	RW	RAM		Current Measured Input 24Value indicates the current measured value of input 24.

UNIVERSAL INPUTS 1-24, FE01-FE18

Attribute	Data Type	Access	Storage	Default	Description
AD	FE	RW	NRAM	0	<p>Alarm Delay specifies the amount of time that the input must exceed a limit before an alarm condition is generated.</p> <p>0=Disable 1-255 Seconds</p>
AE	FE	RW	NRAM	0	<p>Alarm Enable specifies the type of alarming to be used by the input.</p> <p>0=Disabled 1=Contact 0>1 2=Contact 1>0 3=Change of State 4=Low Limit 5=High Limit 6=Low & Hi Limit 8=Fire 11=Supervise DO1 12=Supervise DO2 13=Supervise DO3 14=Supervise DO4 15=Supervise DO5 16=Supervise DO6 17=Supervise DO7 18=Supervise DO8 19=Supervise DO9 20=Supervise DO10 21=Supervise DO11 22=Supervise DO12</p>
AS	FE	RO	RAM	0	<p>Alarm Status indicates the alarm state for the input.</p> <p>0=Normal 1=Contact 0>1 2=Contact 1>0 3=Change of State 5=Low Limit 6=High Limit 8=Fire 10=Runtime 11=Supervisory</p>
CV	FE	RW	RAM	0	<p>Current Measured Input Value displays the scaled value of the associated universal input.</p>
DF	FE	RW	NRAM	0	<p>Display Format specifies the way in which the stat will display the temperature.</p> <p>0=##d 1=##.#d 2=##dF 3=##.#dF</p>
DT	FE	RW	NRAM	254	<p>PUP Datatype for Input specifies the PUP datatype for the input.</p>
GI	FE	RW	NRAM	0	<p>GID of I/O Device indicated the global identification number of the STATbus device associated with the universal input. If the inputs does not have a STATbus device mapped to it, GI will be 0.</p>
HL	FE	RW	NRAM	0	<p>High Alarm Limit if alarming is enabled and the current value, CV, rises above HL, then a high limit alarm will be generated.</p>

Attribute	Data Type	Access	Storage	Default	Description
HS	FE	RW	NRAM	0	Alarm Limit Hysteresis specifies a value that determines when the controller returns from a high- or low-alarm limit. The current value, CV , must be HS below HL or HS above LL before a limit return is generated.
IF	FC	RW	NRAM	0	Input Filter Delay or Weighted Gain the debounce time (in seconds) during which the input must remain stable to avoid the signal being read as a digital bounce. In the case of a bounce, the channel reliability, RE , is set to 1. For analog inputs, IF specifies a weighted gain used to smooth the values from a fluctuating input.
IP	FE	RW	NRAM	0	Input Polarity specifies how the controller represents the input internally. 0=Normal Polarity. Low Voltage is displayed as CV =0 and High Voltage is displayed as CV =1. 1=Reverse Polarity. Low Voltage is displayed as CV =1 and High Voltage is displayed as CV =0.
LL	FE	RW	NRAM	0	Low Alarm Limit if alarming is enabled and the current value, CV , drops below LL , then a low limit alarm will be generated.
MN	FE	RW	NRAM	0	Minimum Scaled Value specifies the minimum scaled value in engineering units.
MX	FE	RW	NRAM	0	Maximum Scaled Value specifies the maximum scaled value in engineering units.
OF	FB	RW	NRAM		Input Offset specifies an offset amount to be added to the current value.
OI	FE	RW	NRAM	0	Override Input? allows the current value of the input, CV , to be overridden. 0=No 1=Yes
ON	DF	RW	NRAM	"Universal Input n" where n=1 to 24	Universal Input Name specifies a user definable string that is used to help identify the channel or its function.
RE	FE	RO	RAM		Data Reliability indicates whether the reading from the input is considered reliable. 0=Reliable 1=Unreliable
RH	FC	RW	RAM	0	Run Hours indicates the number of hours CV =1 for the input.
RL	FC	RW	NRAM	0	Run Limit specifies a number of hours that CV =1 after which a run limit alarm is generated. Setting RL =0.0 disabled run limit alarms for the input.

Attribute	Data Type	Access	Storage	Default	Description
SM	E9	RW	NRAM	0	<p>Schedules to Follow enables scheduled alarm controlling for the associated universal input by selecting one or more of the available schedule control channels.</p> <p>0=Schedule disabled 1=Schedule enabled</p> <p>SM is a bitmap with bit #0=F901 bit #1=F902 bit #2=F903 bit #3=F904 bit #4=F905 bit #5=F906 bit #6=F907 bit #7=F908 bit #8=SMARTStat1 bit #9=SMARTStat2 bit #10=SMARTStat3 bit #11=SMARTStat4 bit #12=SMARTStat5 bit #13=SMARTStat6 bit #14=SMARTStat7 bit #15=SMARTStat8 bit #16=SMARTStat9 bit #17=SMARTStat10 bit #18=SMARTStat11 bit #19=SMARTStat12 bit #20=Host Schedule bit #21=F900 bit #22=FC01</p>
ST	FE	RW	NRAM	0	<p>Sensor Type specifies the type of sensor connected to the input.</p> <p>0=Digital 2=MN..MX 0 to 5V 3=MN..MX 4 to 20mA 4=Curve 1 5=Curve 2 6=MN..MX 0 to 10V 7=Thermistor -30.0 to 230.0 8=MN..MX 0 to 20mA 9=SMARTStat Temperature 10=SMARTStat Humidity</p>
SU	FC	RW	NRAM	0	<p>Amount to Setup/Setback Alarm Limit specifies a value (0.0 to 25.5) which is added to HL and subtracted from LL during scheduled unoccupied periods.</p>
TM	FE	RW	NRAM	1	<p>Thermostat Multiplier specifies the magnitude of the user setpoint offset. Each press of the up or down buttons on a stat will increment the setpoint by an amount TM. There are five steps above and below the setpoint, providing for a maximum offset amount of 5xTM above or below the setpoint.</p>
ED	FE	RW	NRAM	0	<p>Extended Occupancy Duration specifies the amount of time in minutes to extend override occupancy.</p>
ER	FE	RO	NRAM	0	<p>Extended Occupancy Duration Remaining specifies the amount of time remaining in extended override occupancy.</p>

DIGITAL INPUT SUMMARY, FE30

Attribute	Data Type	Access	Storage	Default	Description
CV	E9	RW	RAM		<p>Current Digital Input Value indicates the current state of the associated digital input.</p> <p>bit #0=FE31 bit #1=FE32 bit #2=FE33 bit #3=FE34 bit #4=FE35 bit #5=FE36 bit #6=FE37 bit #7=FE38</p>
IP	E9	RW	NRAM	0	<p>Input Polarities specifies how the controller represents the input internally.</p> <p>0=Normal polarity. Low Voltage is displayed as present_value=0 and High Voltage is displayed as present_value=1. 1=Reverse polarity. Low Voltage is displayed as present_value=1 and High Voltage is displayed as present_value=0.</p> <p>bit #0=FE31 bit #1=FE32 bit #2=FE33 bit #3=FE34 bit #4=FE35 bit #5=FE36 bit #6=FE37 bit #7=FE38</p>
LP	E9	RW	NRAM	0	<p>Interlock Polarities indicates the individual interlock polarity states for each Digital Input.</p> <p>0=Normal 1=Reverse</p> <p>bit #0=FE31 bit #1=FE32 bit #2=FE33 bit #3=FE34 bit #4=FE35 bit #5=FE36 bit #6=FE37 bit #7=FE38</p>
OI	E9	RW	NRAM	0	<p>Overridden Inputs indicates any inputs which have been overridden.</p> <p>bit #0=FE31 bit #1=FE32 bit #2=FE33 bit #3=FE34 bit #4=FE35 bit #5=FE36 bit #6=FE37 bit #7=FE38</p>
ON	DF	RW	NRAM	"Digital Input Summary"	<p>Digital Inputs Summary Name specifies a user definable string that is used to help identify the channel or its function.</p>

Attribute	Data Type	Access	Storage	Default	Description
RE	E9	RO	RAM		<p>Inputs with Unreliable Values indicates whether the reading from the corresponding digital input is considered reliable.</p> <p>0=Reliable 1=Unreliable</p> <p>RE is a bitmap with bit 1 corresponding to DI1, bit 2=DI2, etc. up to bit 4=DI4.</p>

DIGITAL INPUTS 1-8, FE31-FE38

Attribute	Data Type	Access	Storage	Default	Description
AD	FE	RW	NRAM	0	<p>Alarm Delay specifies the amount of time that the input must exceed a limit before an alarm condition is generated.</p> <p>0=Disable 1-255 seconds</p>
AE	FE	RW	NRAM	0	<p>Alarm Enable specifies the type of alarming to be used by the input.</p> <p>0=Disabled 1=Contact 0>1 2=Contact 1>0 3=Change Of State 8=Fire 11=Supervise DO1 12=Supervise DO2 13=Supervise DO3 14=Supervise DO4 15=Supervise DO5 16=Supervise DO6 17=Supervise DO7 18=Supervise DO8 19=Supervise DO9 20=Supervise DO10 21=Supervise DO11 22=Supervise DO12</p>
AS	FE	RO	RAM	0	<p>Alarm Status indicates the alarm state for the input.</p> <p>0=Normal 1=Contact 0>1 2=Contact 1>0 3=Change of state 8=Fire 10=Runtime 11=Supervisory</p>
CV	FE	RW	NRAM		<p>Current Input Value indicates the current state of the associated digital input.</p>
DT	FE	RW	NRAM	254	<p>PUP Datatype for Input specifies the PUP datatype for the input.</p>
GI	FE	RW	NRAM	0	<p>GID of I/O Device indicated the global identification number of the STATbus device associated with the output. If the inputs does not have a STATbus device mapped to it, GI will be 0.</p>
IF	FC	RW	NRAM	0	<p>Input Filter Delay the debounce time (in seconds) during which the input must remain stable to avoid the signal being read as a digital bounce. In the case of a bounce, the channel reliability, RE, is set to 1.</p>
IP	FE	RW	NRAM	0	<p>Input Polarity specifies how the controller represents the input internally.</p> <p>0=Normal polarity. Low Voltage is displayed as CV=0 and High Voltage is displayed as CV=1. 1=Reverse polarity. Low Voltage is displayed as CV=1 and High Voltage is displayed as CV=0.</p>

Attribute	Data Type	Access	Storage	Default	Description
MD	FE	RW	NRAM		<p>Pulse Counter Mode defines how the GPC detects a pulse.</p> <p>0=Rising edge 1=Falling edge</p>
NP	FE	RW	NRAM		<p>Number of Pulses Accumulated displays the current number of pulses detected on the digital input selected in IC.</p>
OI	FE	RW	NRAM	0	<p>Override Input? allows the current value of the input, CV, to be overridden.</p> <p>0=No 1=Yes</p>
ON	DF	RW	NRAM	"Digital Input n" where n=1 to 4	<p>Digital Input Name specifies a user definable string that is used to help identify the channel or its function.</p>
RE	FE	RO	RAM		<p>Data Reliability; indicates whether the reading from the corresponding digital input is considered reliable.</p> <p>0=Reliable 1=Unreliable</p>
RH	FC	RW	RAM		<p>Run Hours indicates the number of hours CV=1 for the input.</p>
RL	FC	RW	NRAM	0	<p>Run Limit specifies a number of hours that CV=1 after which a run limit alarm is generated. Setting RL=0.0 disabled run limit alarms for the input.</p>
SF	F8	RW	NRAM		<p>Pulse Multiplier specifies a scaling factor (0.000 to 65.535) that is multiplied by NP to obtain a scaled count.</p>
SM	E9	RW	NRAM	0	<p>Schedules to Follow enables scheduled alarm controlling for the associated universal input by selecting one or more of the available schedule control channels.</p> <p>0=Schedule disabled 1=Schedule enabled</p> <p>SM is a bitmap with bit #0=F901 bit #1=F902 bit #2=F903 bit #3=F904 bit #4=F905 bit #5=F906 bit #6=F907 bit #7=F908 bit #8=SMARTStat1 bit #9=SMARTStat2 bit #10=SMARTStat3 bit #11=SMARTStat4 bit #12=SMARTStat5 bit #13=SMARTStat6 bit #14=SMARTStat7 bit #15=SMARTStat8 bit #16=SMARTStat9 bit #17=SMARTStat10 bit #18=SMARTStat11 bit #19=SMARTStat12 bit #20=Host Schedule bit #21=F900 bit #22=FC01</p>

Attribute	Data Type	Access	Storage	Default	Description
ST	FE	RW	NRAM	0	Sensor Type specifies the type of sensor connected to the input. 0=Digital 1=Pulse counter
SV	F8	RO	RAM		Scaled Pulse Count displays a scaled version of NP using the formula SV = NP x SF

OCCUPANCY DETECTOR, FC01

Attribute	Data Type	Access	Storage	Default	Description
IA	DF	RW	NRAM		Input Attribute for Occupancy Duration specifies the attribute associated with the channel specified in IC to be used for occupancy detection.
IC	DF	RW	NRAM		Input Channel for Occupancy Duration specifies the channel of the input to be used for occupancy detection.
MD	FE	RW	NRAM	0	Extended Occupancy Delay specifies the time, in minutes, that the occupancy detector status, MS , must be positive before the controller will switch to occupied mode.
MR	FE	RO	RAM		Extended Occupancy Remaining indicates the time, in minutes, before the controller reverts to unoccupied mode.
MS	FE	RO	RAM		Occupancy Status indicates whether the channel and attribute specified in IC and IA indicate that the monitored zone is occupied.
MT	FE	RW	NRAM	0	Extended Occupancy Duration specifies the time, in minutes, that the controller will stay in occupied mode once occupancy is detected.
ON	DF	RW	NRAM	"Occupancy Detector"	Occupancy Output Name specifies a user definable string that is used to help identify the channel or its function.

ANALOG OUTPUT SUMMARY, FD00

Attribute	Data Type	Access	Storage	Default	Description
AM	E9	RW	RAM		<p>Outputs in Automatic Mode specifies how the analog output is controlled.</p> <p>0=Manual 1=Automatic</p> <p>AM is a bitmap with bit 1 corresponding to AO1, bit 2=AO2, etc. up to bit 12=AOC.</p>
CF	FE	RW	NRAM	0	<p>Outputs Enabled for Communication Failure</p>
ON	DF	RW	NRAM	"Analog Output Summary"	<p>Analog Output Summary Name specifies a user definable string that is used to help identify the channel or its function.</p>
RE	E9	RO	RAM		<p>Outputs with Unreliable States indicates whether the reading from the corresponding analog output is considered reliable.</p> <p>0=Reliable 1=Unreliable</p> <p>RE is a bitmap with bit 1 corresponding to AO1, bit 2=AO2, etc. up to bit 12=AOC.</p>
V1	FC	RW	RAM		<p>Current Value for Output 1 indicates the current value of output 1.</p>
V2	FC	RW	RAM		<p>Current Value for Output 2 indicates the current value of output 2.</p>
V3	FC	RW	RAM		<p>Current Value for Output 3 indicates the current value of output 3.</p>
V4	FC	RW	RAM		<p>Current Value for Output 4 indicates the current value of output 4.</p>
V5	FC	RW	RAM		<p>Current Value for Output 5 indicates the current value of output 5.</p>
V6	FC	RW	RAM		<p>Current Value for Output 6 indicates the current value of output 6.</p>
V7	FC	RW	RAM		<p>Current Value for Output 7 indicates the current value of output 7.</p>
V8	FC	RW	RAM		<p>Current Value for Output 8 indicates the current value of output 8.</p>
V9	FC	RW	RAM		<p>Current Value for Output 9 indicates the current value of output 9.</p>
VA	FC	RW	RAM		<p>Current Value for Output 10 indicates the current value of output 10.</p>
VB	FC	RW	RAM		<p>Current Value for Output 11 indicates the current value of output 11.</p>
VC	FC	RW	RAM		<p>Current Value for Output 12 indicates the current value of output 12.</p>

ANALOG OUTPUTS 1-12, FD01-FD0C

Attribute	Data Type	Access	Storage	Default	Description
AM	FE	RW	NRAM	0	Control Mode specifies how the analog output is controlled. 0=Manual 1=Automatic
CF	FE	RW	NRAM	0	Communication Failure Enable? 0=No 1=Yes
CV	FC	RW	RAM		Current Output Value indicates the current value of the associated analog output.
DT	FE	RW	NRAM	252	PUP Datatype for Output specifies the PUP datatype for the output.
FI	FC	RW	NRAM	0	Fire Position specifies the failure position (0-100%) for the output to be used when a fire event is received.
FP	FC	RW	NRAM	0.0	Interlock/Communication Failure Position specifies the failure position (0-100%) for the output to be used in the event of an interlock or communications failure.
GI	FE	RW	NRAM	0	GID of I/O Device indicated the global identification number of the STATbus device associated with the analog output. If the input does not have a STATbus device mapped to it, GI will be 0.
HS	FA	RW	NRAM	100	Maximum Scaled Voltage specifies the percentage of the total output for CV=MX .
IL	E9	RW	NRAM	0	Inputs for Interlocking specifies which inputs (if any) are used as interlocks for the associated output (a value of 1 indicates that input is used for interlocking). IL is a bitmap with bit 1 corresponding to UI1, bit 2=UI2, etc. up to bit 24=UI24.
LS	FA	RW	NRAM	0	Minimum Scaled Voltage specifies the percentage of the total output for CV=MN .
MN	FE	RW	NRAM	0	Minimum Scaled Value specifies the minimum value for a scaled reading of CV , in Engineering Units.
MX	FE	RW	NRAM	100	Maximum Scaled Value specifies the maximum value for a scaled reading of CV , in Engineering Units.
ON	DF	RW	NRAM	"Analog Output n" where n=1 to 12	Analog Output Name specifies a user definable string that is used to help identify the channel or its function.
OU		RO	RAM		Actual Output Value indicates the actual output value of the analog output.
RE	FE	RO	RAM		Data Reliability indicates whether the reading from the corresponding analog output is considered reliable. 0=Reliable 1=Unreliable

Attribute	Data Type	Access	Storage	Default	Description
UT	FE	RW	NRAM	0	Update Threshold specifies a threshold value by which CV must change before the output is updated.

DIGITAL OUTPUT SUMMARY, FB00

Attribute	Data Type	Access	Storage	Default	Description
AM	E9	RW	NRAM	0	<p>Outputs in Automatic Mode specifies how the digital output is controlled.</p> <p>0=Manual 1=Automatic</p> <p>bit #0=BO1 bit #1=BO2 bit #2=BO3 bit #3=BO4 bit #4=BO5 bit #5=BO6 bit #6=BO7 bit #7=BO8 bit #8=BO9 bit #9=BO10 bit #10=BO11 bit #11=BO12</p>
CF	E9	RW	NRAM	0	<p>Outputs Enabled for Communication Fail specifies which outputs will be enabled in the event that a communication failure is detected.</p> <p>bit #0=BO1 bit #1=BO2 bit #2=BO3 bit #3=BO4 bit #4=BO5 bit #5=BO6 bit #6=BO7 bit #7=BO8 bit #8=BO9 bit #9=BO10 bit #10=BO11 bit #11=BO12</p>
CV	E9	RW	RAM	0	<p>Digital Outputs which are On indicates which outputs are currently on.</p> <p>bit #0=BO1 bit #1=BO2 bit #2=BO3 bit #3=BO4 bit #4=BO5 bit #5=BO6 bit #6=BO7 bit #7=BO8 bit #8=BO9 bit #9=BO10 bit #10=BO11 bit #11=BO12</p>
FE	E9	RW	NRAM	0	<p>Outputs Enabled for Fire specifies which outputs will be enabled in the event that a fire event is detected.</p> <p>bit #0=BO1 bit #1=BO2 bit #2=BO3 bit #3=BO4 bit #4=BO5 bit #5=BO6 bit #6=BO7 bit #7=BO8 bit #8=BO9 bit #9=BO10 bit #10=BO11 bit #11=BO12</p>

Attribute	Data Type	Access	Storage	Default	Description
FI	E9	RO	NRAM	0	<p>Fire Positions indicates which digital outputs are in fire mode.</p> <p>bit #0=BO1 bit #1=BO2 bit #2=BO3 bit #3=BO4 bit #4=BO5 bit #5=BO6 bit #6=BO7 bit #7=BO8 bit #8=BO9 bit #9=BO10 bit #10=BO11 bit #11=BO12</p>
FS	E9	RO	NRAM	0	<p>Communication Failure Positions indicates which outputs are currently experiencing communications failures.</p> <p>bit #0=BO1 bit #1=BO2 bit #2=BO3 bit #3=BO4 bit #4=BO5 bit #5=BO6 bit #6=BO7 bit #7=BO8 bit #8=BO9 bit #9=BO10 bit #10=BO11 bit #11=BO12</p>
IS	FE	RW	NRAM	0	<p>Inter-Stage Delay specifies a minimum delay, in seconds (0-255) that must elapse after a staged output is energized before subsequent stages may be energized.</p>
ON	DF	RW	NRAM	"Digital Output Summary"	<p>Digital Outputs Summary Name specifies a user definable string that is used to help identify the channel or its function.</p>
OU	E9	RO	RAM		<p>Actual Output States indicates the actual output states of the digital outputs.</p> <p>bit #0=BO1 bit #1=BO2 bit #2=BO3 bit #3=BO4 bit #4=BO5 bit #5=BO6 bit #6=BO7 bit #7=BO8 bit #8=BO9 bit #9=BO10 bit #10=BO11 bit #11=BO12</p>

Attribute	Data Type	Access	Storage	Default	Description
RE	FE	RO	RAM		<p>Outputs with Unreliable Values indicates whether the reading from the corresponding digital output is considered reliable.</p> <p>0=Reliable 1=Unreliable</p> <p>bit #0=BO1 bit #1=BO2 bit #2=BO3 bit #3=BO4 bit #4=BO5 bit #5=BO6 bit #6=BO7 bit #7=BO8 bit #8=BO9 bit #9=BO10 bit #10=BO11 bit #11=BO12</p>
SB	E9	RW	NRAM	0	<p>Outputs Enabled for Staging selects two or more digital outputs to be grouped together for staging.</p> <p>bit #0=BO1 bit #1=BO2 bit #2=BO3 bit #3=BO4 bit #4=BO5 bit #5=BO6 bit #6=BO7 bit #7=BO8 bit #8=BO9 bit #9=BO10 bit #10=BO11 bit #11=BO12</p>

DIGITAL OUTPUTS 1-12, FB01-FB0C

Attribute	Data Type	Access	Storage	Default	Description
AM	FE	RW	NRAM	0	Control Mode specifies how the digital output is controlled. 0=Manual 1=Automatic
AS	FE	RO	RAM	0	Alarm Status indicates the alarm state for the input. 0=Normal 1=Contact 0>1 2=Contact 1>0 3=Change of state 8=Fire 10=Runtime 11=Supervisory
CV	FE	RW	RAM	0	Requested Output Value specifies the current state of output. Because of various delays, this value may differ from OU . 0=Off 1=On
FT	FE	RW	NRAM		Minimum Off Time specifies the minimum time in second that must elapse after the output is turned off before it may be re-energized.
GI	FE	RW	NRAM	0	GID of I/O Device indicated the global identification number of the STATbus device associated with the digital output. If the inputs does not have a STATbus device mapped to it, GI will be 0.
NT	FE	RW	NRAM	0	Minimum On Time specifies the minimum time in seconds that must elapse after the output is energized before it may be turned off.
ON	DF	RW	NRAM	"Digital Output n" where n=1 to 12	Digital Output Name specifies a user definable string that is used to help identify the channel or its function.
OU	FE	RO	RAM	0	Actual Output Value specifies the actual state of the output. 0=Off 1=On
PW	FC	RW	NRAM	0	Pulse Width when Output is On specifies the "on" time (CV =1) in seconds (0.0 to 25.5) that the output should remain on after a transition from the off to on state. 0=Disabled 0.1-25.5=pulse "on" duration in seconds
RE	FE	RO	RAM		Data Reliability indicates whether the reading from the corresponding digital output is considered reliable. 0=Reliable 1=Unreliable
RH	FC	RW	NRAM	0	Run Hours indicates the number of hours CV =1 for the input.

Attribute	Data Type	Access	Storage	Default	Description
RL	FC	RW	NRAM	0	Run Hours Limit specifies a number of hours that CV=1 after which a run limit alarm is generated. Setting RL=0.0 disabled run limit alarms for the input.
SI	FE	RW	NRAM	0	Power-On Stagger Interval specifies the time, in seconds, that must elapse after the controller is turned on or reset before the output can be turned on.
SM	E9	RW	NRAM	0	Schedules to Follow enables scheduled alarm controlling for the associated digital output by selecting one or more of the available schedule control channels. 0=Schedule disabled 1=Schedule enabled SM is a bitmap with bit #0=F901 bit #1=F902 bit #2=F903 bit #3=F904 bit #4=F905 bit #5=F906 bit #6=F907 bit #7=F908 bit #8=SMARTStat1 bit #9=SMARTStat2 bit #10=SMARTStat3 bit #11=SMARTStat4 bit #12=SMARTStat5 bit #13=SMARTStat6 bit #14=SMARTStat7 bit #15=SMARTStat8 bit #16=SMARTStat9 bit #17=SMARTStat10 bit #18=SMARTStat11 bit #19=SMARTStat12 bit #20=Host Schedule bit #21=F900 bit #22=FC01

PID CONTROL 1-12, FA01-FA0C

Attribute	Data Type	Access	Storage	Default	Description
AO	FB	RO	RAM	0	Analog Output Value displays the output of the PID loop.
CE	FE	RW	NRAM	0	Enable Control Loop? enables/disables PID control. 0=No 1=Yes
CS	FB	RO	RAM	0	Calculated Control Setpoint specifies the effective (calculated) setpoint accounting for setup/ setback, manual setpoint adjustments, etc.
DB	FB	RW	NRAM	0	Desired Control Deadband specifies the deadband that is used to control cycling around the setpoint. If the current value of the input channel is between SP-(DB/2) and SP+(DB/2) , the measured variable is considered to be at its setpoint.
DL	FB	RO	NRAM		Demand Load indicates the demand load for the control loop. This is the amount by which CS differs from the loop measured variable specified in IC and IA .
IA	DF	RW	NRAM		Loop Measured Attribute specifies the attribute associated with the channel specified in IC to be used as the measured variable for PID control loop.
IC	DF	RW	NRAM		Loop Measured Channel specifies the input channel to be used as the measured variable for the PID control loop.
MR	FD	RW	NRAM	0	Maximum Amount to Reset Setpoint the maximum amount to reset the control loop setpoint.
OH	FB	RW	NRAM	100	Output High Limit defines the maximum output for the PID control loop.
OL	FB	RW	NRAM	0	Output Low Limit defines the minimum output for the PID control loop.
ON	DF	RW	NRAM	"PID Control n" where n=1 to 12	Control Loop Name specifies a user definable string that is used to help identify the channel or its function.
PB	FD	RW	NRAM	0	Proportional Control Band specifies a range, centered around the loop setpoint SP , where the output signal is proportional. If the value of the selected input channel is outside the proportional band, the proportional component of the PID calculation is clamped at OL or OH as appropriate.
PO	FB	RW	NRAM	0	Percent Output Value displays the calculated output of the PID control loop. PO ranges from OL to OH .
RA	DF	RW	NRAM	00	Reset Attribute specifies the attribute associated with the channel specified in RC to be used as the reset variable for the PID control loop.
RC	DF	RW	NRAM	0	Reset Channel specifies the input channel to be used as the reset variable for the PID control loop.

Attribute	Data Type	Access	Storage	Default	Description
RL	FD	RW	NRAM	0	Limit for Maximum Reset specifies the reset limit of the control loop. When RV reaches a value of RL , the control loop setpoint will be reset by the maximum amount RV .
RP	FE	RW	NRAM	0	Reset Period specifies a time, in seconds (0 to 65,535) over which the output of the control loop should be adjusted (reset) using integral action. 0=Disabled 1 to 65,535=Integral reset period, in seconds
RS	FD	RW	NRAM	0	Setpoint at which Reset Action Begins specifies the setpoint of the control loop at which reset action begins.
RT	FD	RW	NRAM	0	Derivative Rate specifies a a percentage of the amount of derivative error that is contributed each second to the PID output of the control loop (0.0 to 25.5%). 0.0=Disable 0.1 to 25.5=Derivative rate in %/second
SG	FE	RW	NRAM	0	Control Action specifies whether the controller's output should be increased or decreased when error is positive. 0=Normal (increase for positive error) 1=Reverse (decrease for positive error)
SM	E9	RW	NRAM	0	Schedules to Follow enables scheduled alarm controlling for the associated PID control loop by selecting one or more of the available schedule control channels. 0=Schedule disabled 1=Schedule enabled SM is a bitmap with bit #0=F901 bit #1=F902 bit #2=F903 bit #3=F904 bit #4=F905 bit #5=F906 bit #6=F907 bit #7=F908 bit #8=SMARTStat1 bit #9=SMARTStat2 bit #10=SMARTStat3 bit #11=SMARTStat4 bit #12=SMARTStat5 bit #13=SMARTStat6 bit #14=SMARTStat7 bit #15=SMARTStat8 bit #16=SMARTStat9 bit #17=SMARTStat10 bit #18=SMARTStat11 bit #19=SMARTStat12 bit #20=Host Schedule bit #21=F900 bit #22=FC01
SP	FB	RW	NRAM	0	Loop Setpoint specifies the desired value of the variable selected in IC and IA .
SR	FE	RW	NRAM	100	Soft Start Ramp specifies the maximum percentage change per minute for the associated output under the following conditions: when the controller is initially powered up or reset; upon transitions from unoccupied to occupied mode and upon cancellation of an interlock failure or fire condition.

Attribute	Data Type	Access	Storage	Default	Description
SU	FD	RW	NRAM	0	Unoccupied Setup/Setback specifies a value (0.0 to 25.5) which is added to (if SG=1) or subtracted from (if SG=0) the control loop setpoint during scheduled unoccupied periods.
TS	FD	RO	NRAM		Thermostat SP Adjustment indicates any setpoint adjustments read in from a SmartSTAT.

THERMOSTATIC CONTROL 1-12, FA11-FA1C

Attribute	Data Type	Access	Storage	Default	Description
CE	FE	RW	NRAM	0	Enable Control Loop? enables/disables thermostatic control for the associated control loop. 0=Disabled 1=Enabled
CS	FB	RO	RAM	0	Calculated Control Setpoint specifies the calculated (actual) control setpoint that is used by the thermostatic control loop. CS accounts for the effects of setup/setback (SU) during scheduled unoccupied periods.
CV	FE	RW	RAM	0	Current Value indicates the current desired state of the output(s) selected in OB .
DB	FB	RW	NRAM	0	Desired Control DeadBand specifies a control hysteresis that is used to keep CV from toggling when the value is on the border between two states.
DL	FB	RO	NRAM		Demand Load indicates the demand load for the control loop. This is the amount by which CS differs from the loop measured variable specified in IC and IA .
IA	DF	RW	NRAM		Loop Measured Attribute specifies the attribute associated with the channel specified in IC to be used as the measured variable for Thermostatic control loop.
IC	DF	RW	NRAM		Loop Measured Channel specifies the input channel to be used as the measured variable for the Thermostatic control loop.
OB	E9	RW	NRAM	0	Output Bitmap specify which digital outputs will be controlled by the thermostatic control loop. bit #0=BO1 bit #1=BO2 bit #2=BO3 bit #3=BO4 bit #4=BO5 bit #5=BO6 bit #6=BO7 bit #7=BO8 bit #8=BO9 bit #9=BO10 bit #10=BO11 bit #11=BO12
ON	DF	RW	NRAM	"Thermostatic Control n" where n=1 to 4	Thermostatic Control Name specifies a user definable string that is used to help identify the channel or its function.
RA	DF	RW	NRAM		Reset Attribute specifies the attribute associated with the channel specified in IC to be used for thermostatic control.
RC	DF	RW	NRAM		Reset Channel specifies the channel to be used for thermostatic control.
SG	FE	RW	NRAM	0	Control Action specifies the control sign for the thermostatic control application. 0=Cooling 1=Heating

Attribute	Data Type	Access	Storage	Default	Description
SM	E9	RW	NRAM	0	<p>Schedules to Follow enables scheduled alarm controlling for the thermostatic control loop by selecting one or more of the available schedule control channels.</p> <p>0=schedule disabled 1=schedule enabled</p> <p>SM is a bitmap with bit #0=F901 bit #1=F902 bit #2=F903 bit #3=F904 bit #4=F905 bit #5=F906 bit #6=F907 bit #7=F908 bit #8=SMARTStat1 bit #9=SMARTStat2 bit #10=SMARTStat3 bit #11=SMARTStat4 bit #12=SMARTStat5 bit #13=SMARTStat6 bit #14=SMARTStat7 bit #15=SMARTStat8 bit #16=SMARTStat9 bit #17=SMARTStat10 bit #18=SMARTStat11 bit #19=SMARTStat12 bit #20=Host Schedule bit #21=F900 bit #22=FC01</p>
SP	FB	RW	NRAM	0	<p>Loop Setpoint specifies the desired setpoint for the thermostatic control loop.</p>
SU	FB	RW	NRAM	0	<p>Unoccupied Setup/Setback specifies a value (0.0 to 25.5) which is added to the control setpoint during scheduled unoccupied periods.</p>
TS	FD	RO	NRAM		<p>Thermostat SP Adjustment indicates any setpoint adjustments read in from a SmartSTAT.</p>

FLOATING POINT CONTROL 1-2, FA21-FA22

Attribute	Data Type	Access	Storage	Default	Description
CE	FE	RW	NRAM	0	<p>Enable Control Loop? enables/disables floating point control for the associated control loop.</p> <p>0=No 1=Yes</p>
CF	FE	RW	NRAM	0	<p>Communication Failure Enable? specifies what action to take in the event that a communication failure is detected.</p> <p>0=No 1=Yes</p>
CP	FB	RO	RAM	0	<p>Current Position indicates the current position of the motor.</p>
CR	FE	RW	NRAM	0	<p>Motor Creep Function specifies how the controller handles automatic calibrations at minimum and maximum positions.</p> <p>0=Drive motor constantly if DP=0% or DP=100% 1=Creep motor output by 1% per minute if DP=0% or DP=100%</p>
CS	FB	RO	RAM	0	<p>Calculated Control Setpoint indicates the calculated control setpoint. This value accounts for any reset or setup/setback action on the loop setpoint.</p>
DB	FB	RW	NRAM	0	<p>Desired Control Deadband specifies the deadband that is used to control cycling around the setpoint. If the current value of the input channel is between $SP-(DB/2)$ and $SP+(DB/2)$, the measured variable is considered to be at its setpoint</p>
DL	FB	RO	NRAM		<p>Demand Load indicates the demand load for the control loop. This is the amount by which CS differs from the loop measured variable specified in IC and IA.</p>
DO	FE	RW	NRAM	0	<p>Digital Output Pair Selection specifies which Digital Output pair is to be used for floating point control.</p> <p>0=none 1=D01+D02 2=D03+4 3=D05+6 4=D07+8 5=D09+10 6=D011+12</p>
DP	FB	RW	NRAM	0	<p>Desired Position specifies the desired output position (0-100%) of the associated motor.</p>
FI	FB	RW	NRAM	0	<p>Fire Position specifies the failure position (0-100%) to use when a fire event is detected.</p>
FP	FB	RW	NRAM	0	<p>Interlock/Comm Failure Position specifies the failure position (0-100%) to use when an input interlock failure occurs. FP is used when the current value of any of the inputs specified by IL has a value of 1.</p>
IA	DF	RW	NRAM		<p>Input Attribute specifies the channel to be used for floating point control.</p>

Attribute	Data Type	Access	Storage	Default	Description
IC	DF	RW	NRAM		Input Channel specifies the attribute associated with the channel specified in IC to be used for floating point control.
IL	E9	RW	NRAM	0	Input for Interlock specifies which inputs are to be used for interlocking of the associated floating point control loop. IL is a bitmap with bit 1 corresponding to IUI1, bit 2=UI2, etc. up to bit 12=UIO.
MR	FB	RW	NRAM	0	Maximum Amount to Reset Setpoint specifies the maximum amount o reset SP .
ON	DF	RW	NRAM	"Floating Point Control n" where n=1 to 2	Floating Point Name specifies a user definable string that is used to help identify the channel or its function.
PB	FB	RW	NRAM	0	Proportional Control Band specifies a range, centered around the loop setpoint SP , where the output signal is proportional.
PE	FE	RW	NRAM	0	Floating Point Controlled Pair Enable specifies whether the motor is to be controlled using pulsed pairs. 0=No 1=Yes
RA	DF	RW	NRAM		Reset Attribute specifies the attribute associated with the channel specified in RC to determine reset.
RC	DF	RW	NRAM		Reset Channel specifies the channel to be used to determine reset.
RI	FE	RW	NRAM	0	Motor Recalibrate Interval specifies a time interval in hours (0-255) the defines how often the associated floating point control loop is recalibrated. 0=Calibration disabled RI > 0 =Recalibrate every RI hours
RL	FB	RW	NRAM	0	Limit for Maximum Reset specifies the reset limit of the control loop. When the reset variable specified in RV and RA reaches a value of RL , the control loop setpoint will be reset by the maximum amount MR .
RP	FE	RW	NRAM	0	Reset Period specifies a time, in seconds (0 to 65,535) over which the output of the control loop should be adjusted (reset). 0=Disabled 1 to 65,535=Reset period, in seconds
RS	FB	RW	NRAM	0	Setpoint at which Reset Action Begins specifies the setpoint of the control loop at which reset action begins.
SG	FE	RW	NRAM	0	Control Action specifies whether the controller's output should be increased or decreased when the control signal is positive. 0=Normal (increase for positive error) 1=Reverse (decrease for positive error)

Attribute	Data Type	Access	Storage	Default	Description
SM	E9	RW	NRAM	0	<p>Schedules to Follow enables scheduled alarm controlling by selecting one or more of the available schedule control channels.</p> <p>0=Schedule disabled 1=Schedule enabled</p> <p>SM is a bitmap with bit #0=F901 bit #1=F902 bit #2=F903 bit #3=F904 bit #4=F905 bit #5=F906 bit #6=F907 bit #7=F908 bit #8=SMARTStat bit #9=Host Override</p>
SP	FB	RW	NRAM	0	<p>Loop Setpoint specifies the desired setpoint for the floating point control loop.</p>
SU	FB	RW	NRAM	0	<p>Unoccupied Setup/Setback specifies a value (0.0 to 25.5) which is added to (if SG=1) or subtracted from (if SG=0) the control loop setpoint during scheduled unoccupied periods</p>
TS	FD	RO	NRAM		<p>Thermostat SP Adjustment indicates any setpoint adjustments read in from a SmartSTAT.</p>
TT	FE	RW	NRAM	0	<p>Motor Travel Time specifies the time, in seconds (0-3000), that it takes the motor to move from its fully closed to its fully open positions.</p>

SCHEDULE SUMMARY, F900

Attribute	Data Type	Access	Storage	Default	Description
AS	E9	RO	RAM		<p>Active Schedules lists the schedules which are currently active.</p> <p>bit #0=F901 bit #1=F902 bit #2=F903 bit #3=F904 bit #4=F905 bit #5=F906 bit #6=F907 bit #7=F908</p>
C1	FE	RO	RAM		<p>Schedule 1 indicates the current state of Schedule 1.</p> <p>0=Unoccupied 1=Warm-up 2=Occupied 3=Night setback</p>
C2	FE	RO	RAM		<p>Schedule 2 indicates the current state of Schedule 2</p> <p>0=Unoccupied 1=Warm-up 2=Occupied 3=Night setback</p>
C3	FE	RO	RAM		<p>Schedule 3 indicates the current state of Schedule 3.</p> <p>0=Unoccupied 1=Warm-up 2=Occupied 3=Night setback</p>
C4	FE	RO	RAM		<p>Schedule 4 indicates the current state of Schedule 4.</p> <p>0=Unoccupied 1=Warm-up 2=Occupied 3=Night setback</p>
C5	FE	RO	RAM		<p>Schedule 5 indicates the current state of Schedule 5.</p> <p>0=Unoccupied 1=Warm-up 2=Occupied 3=Night setback</p>
C6	FE	RO	RAM		<p>Schedule 6 indicates the current state of Schedule 6.</p> <p>0=Unoccupied 1=Warm-up 2=Occupied 3=Night setback</p>
C7	FE	RO	RAM		<p>Schedule 7 indicates the current state of Schedule 7.</p> <p>0=Unoccupied 1=Warm-up 2=Occupied 3=Night setback</p>

Attribute	Data Type	Access	Storage	Default	Description
C8	FE	RO	RAM		Schedule 8 indicates the current state of Schedule 8. 0=Unoccupied 1=Warm-up 2=Occupied 3=Night setback
CV	FE	RO	RAM		Current Schedule Value indicates the current state of the controller. 0=Unoccupied 1=Warm-up 2=Occupied 3=Night setback
DH	FE	RW	NRAM	0	Holiday? specifies whether today is one of the holidays specified in H0-H9 .
H0	E4	RW	NRAM	0	Programmed Holiday
H1	E4	RW	NRAM	0	Programmed Holiday
H2	E4	RW	NRAM	0	Programmed Holiday
H3	E4	RW	NRAM	0	Programmed Holiday
H4	E4	RW	NRAM	0	Programmed Holiday
H5	E4	RW	NRAM	0	Programmed Holiday
H6	E4	RW	NRAM	0	Programmed Holiday
H7	E4	RW	NRAM	0	Programmed Holiday
H8	E4	RW	NRAM	0	Programmed Holiday
H9	E4	RW	NRAM	0	Programmed Holiday
HE	FE	RW	NRAM	0	Enable Host Schedule specifies whether to use the schedule broadcast by the host. 0=No 1=Yes
HO	FE	RW	NRAM	0	Host Schedule Value specifies the desired host schedule override state. 0=Unoccupied 1=Warmup 2=Occupied 3=Night setback
IS	FE	RW	NRAM	0	Inactive State the schedule mode that the controller will default to if there are no schedules which are currently active.
ON	DF	RW	NRAM	"Schedule Summary"	Schedule Summary Name specifies a user definable string that is used to help identify the channel or its function.

Attribute	Data Type	Access	Storage	Default	Description
SO	E9	RO	NRAM	0	<p>Digital Stat Override Status displays the state of each STAT's local override flag.</p> <p>bit #0=SMARTStat 1 bit #1=SMARTStat 2 bit #2=SMARTStat 3 bit #3=SMARTStat 4 bit #4=SMARTStat 5 bit #5=SMARTStat 6 bit #6=SMARTStat 7 bit #7=SMARTStat 8 bit #8=SMARTStat 9 bit #9=SMARTStat 10 bit #10=SMARTStat 11 bit #11=SMARTStat 12</p>
AB	E9	RW	NRAM	0	<p>Access Buttons States displays the state of the remote access control buttons.</p> <p>bit #0=Button 1 bit #1=Button 2 bit #2=Button 3 bit #3=Button 4 bit #4=Button 5 bit #5=Button 6 bit #6=Button 7 bit #7=Button 8 bit #8=Button 9 bit #9=Button 10 bit #10=Button 11 bit #11=Button 12</p>
EA	E9	RW	NRAM	0	<p>Enable Access Buttons enables remote access button presses.</p> <p>bit #0=Enable Button 1 bit #1=Enable Button 2 bit #2=Enable Button 3 bit #3=Enable Button 4 bit #4=Enable Button 5 bit #5=Enable Button 6 bit #6=Enable Button 7 bit #7=Enable Button 8 bit #8=Enable Button 9 bit #9=Enable Button 10 bit #10=Enable Button 11 bit #11=Enable Button 12</p>
OM	E9	RW	NRAM	0	<p>Override Map displays whether or not a STAT is in an override state.</p> <p>bit #0=Override 1 bit #1=Override 2 bit #2=Override 3 bit #3=Override 4 bit #4=Override 5 bit #5=Override 6 bit #6=Override 7 bit #7=Override 8 bit #8=Override 9 bit #9=Override 10 bit #10=Override 11 bit #11=Override 12</p>

SCHEDULES 1-8, F901-F908

Attribute	Data Type	Access	Storage	Default	Description
AD	E9	RW	NRAM	0	<p>Active Days bitmap that specifies which days the schedule is active. Setting the appropriate bit to 1 indicates the schedule will be active on that day.</p> <p>bit #0=Monday bit #1=Tuesday bit #2=Wednesday bit #3=Thursday bit #4=Friday bit #5=Saturday bit #6=Sunday bit #7=Holiday</p>
AO	FE	RW	NRAM	0	<p>All Day Override set the schedule state for the entire day.</p> <p>0=None 1=Unoccupied 2=Warmup 3=Occupied 4=Night SEtback</p>
CV	FE	RO	RAM	0	<p>Current Schedule Value indicates the current state of the schedule.</p> <p>0=Unoccupied 1=Warm-up 2=Occupied 3=Night setback</p>
NS	E6	RW	NRAM	19:00	<p>Time to go Night Setback specifies the time when night setback mode should begin.</p>
OC	E6	RW	NRAM	08:00	<p>Time to go Occupied specifies the time when occupied mode should begin.</p>
ON	DF	RW	NRAM	"Schedule n" where n=1 to 8	<p>Schedule Name specifies a user definable string that is used to help identify the channel or its function.</p>
UN	E6	RW	NRAM	17:00	<p>Time to go Unoccupied specifies the time when unoccupied mode should begin.</p>
WO	E6	RW	NRAM	07:30	<p>Time to go Warm-Up specifies the time when warm-up mode should begin.</p>

SCALES 1-4, F711-F714

Attribute	Data Type	Access	Storage	Default	Description
CV	FC	RO	RAM		Current Value specifies the calculated scaled value.
DT	FE	RW	NRAM	253	PUP Datatype for Values specifies the PUP datatype for the scale.
IA	DF	RW	NRAM	0	Input Attribute specifies the attribute associated with the channel specified in IC to be scaled.
IC	DF	RW	NRAM		Input Channel specifies the channel to be scaled.
ON	DF	RW	NRAM	"Scale n" where n=1 to 4	Scale Name specifies a user definable string that is used to help identify the channel or its function.
X1	FE	RW	NRAM	0	Input range X1 value specifies the minimum value of the input.
X2	FE	RW	NRAM	0	Input range X2 value specifies the maximum value of the input.
Y1	FE	RW	NRAM	0	Output range Y1 value specifies the minimum value of the scaled output.
Y2	FE	RW	NRAM	0	Output range Y2 value specifies the maximum value of the scaled output.

PIECEWISE CURVES 1-2, F701-F702

Attribute	Data Type	Access	Storage	Default	Description
DT	FE	RW	NRAM	253	PUP Datatype specifies the PUP datatype for the piecewise curve.
ON	DF	RW	NRAM	"Piecewise Curve n" where n=1 to 2	Piecewise Curves Name specifies a user definable string that is used to help identify the channel or its function.
X1	FE	RW	NRAM	0	Point 1's value in raw counts specifies the x coordinate of point 1.
X2	FE	RW	NRAM	0	Point 2's value in raw counts specifies the x coordinate of point 2.
X3	FE	RW	NRAM	0	Point 3's value in raw counts specifies the x coordinate of point 3.
X4	FE	RW	NRAM	0	Point 4's value in raw counts specifies the x coordinate of point 4.
X5	FE	RW	NRAM	0	Point 5's value in raw counts specifies the x coordinate of point 5.
X6	FE	RW	NRAM	0	Point 6's value in raw counts specifies the x coordinate of point 6.
X7	FE	RW	NRAM	0	Point 7's value in raw counts specifies the x coordinate of point 7.
X8	FE	RW	NRAM	0	Point 8's value in raw counts specifies the x coordinate of point 8.
X9	FE	RW	NRAM	0	Point 9's value in raw counts specifies the x coordinate of point 9.
XA	FE	RW	NRAM	0	Point 10's value in raw counts specifies the x coordinate of point 10.
XB	FE	RW	NRAM	0	Point 11's value in raw counts specifies the x coordinate of point 11.
Y1	FE	RW	NRAM	0	Point 1's value in engineering units specifies the y coordinate of point 1.
Y2	FE	RW	NRAM	0	Point 2's value in engineering units specifies the y coordinate of point 2.
Y3	FE	RW	NRAM	0	Point 3's value in engineering units specifies the y coordinate of point 3.
Y4	FE	RW	NRAM	0	Point 4's value in engineering units specifies the y coordinate of point 4.
Y5	FE	RW	NRAM	0	Point 5's value in engineering units specifies the y coordinate of point 5.
Y6	FE	RW	NRAM	0	Point 6's value in engineering units specifies the y coordinate of point 6.
Y7	FE	RW	NRAM	0	Point 7's value in engineering units specifies the y coordinate of point 7.

Attribute	Data Type	Access	Storage	Default	Description
Y8	FE	RW	NRAM	0	Point 8's value in engineering units specifies the y coordinate of point 8.
Y9	FE	RW	NRAM	0	Point 9's value in engineering units specifies the y coordinate of point 9.
YA	FE	RW	NRAM	0	Point 10's value in engineering units specifies the y coordinate of point 10.
YB	FE	RW	NRAM	0	Point 11's value in engineering units specifies the y coordinate of point 11.

MATH 1-2, F311-F312

Attribute	Data Type	Access	Storage	Default	Description
A1	DF	RW	NRAM	0	Input Attribute 1 specifies the attribute associated with the first input channel.
A2	DF	RW	NRAM	0	Input Attribute 2 specifies the attribute associated with the second input channel.
CV	FE	RW	RAM	0	Current Value indicates the numeric result of applying the operand specified in OP to the inputs.
DT	FE	RW	NRAM	0	PUP Data Type for Values specifies the PUP datatype for CV .
I1	DF	RW	NRAM	0	Input channel 1 specifies the first input channel.
I2	DF	RW	NRAM	0	Input channel 2 specifies the second input channel.
ON	FC	RW	NRAM	"Math n" where n=1 to 2	Math Channel Name specifies a user definable string that is used to help identify the channel or its function.
OP	FE	RW	NRAM	0	Operation specifies the operation to be performed on the selected channels. 0=Disabled 1=Addition 2=Subtraction 3=Multiplication 4=Division

AVERAGES 1-3, F301-F303

Attribute	Data Type	Access	Storage	Default	Description
A1	DF	RW	NRAM	0	Input Attribute 1 specifies the attribute associated with the first input channel.
A2	DF	RW	NRAM	0	Input Attribute 2 specifies the attribute associated with the second input channel.
A3	DF	RW	NRAM	0	Input Attribute 3 specifies the attribute associated with the third input channel.
A4	DF	RW	NRAM	0	Input Attribute 4 specifies the attribute associated with the fourth input channel.
AV	FC	RW	RAM	0	Average Value displays the arithmetic mean of the inputs selected in I1;A1 through I4;A4 .
DT	FE	RW	NRAM	253	PUP Datatype for Values specifies the PUP datatype for HV , LV , and AV .
HV	FC	RW	NRAM	0	High Value indicated the maximum value of the inputs specified in I1;A1 through I4;A4 .
I1	DF	RW	NRAM	0	Input channel 1 specifies the first input channel.
I2	DF	RW	NRAM	0	Input channel 2 specifies the second input channel.
I3	DF	RW	NRAM	0	Input channel 3 specifies the third input channel.
I4	DF	RW	NRAM	0	Input channel 4 specifies the fourth input channel.
LV	FC	RW	NRAM	0	Low Value indicates the minimum value of the channels specified in I1;A1 through I4;A4 .
ON	DF	RW	NRAM	"Min/Max/Avg n" where n=1 to 3	Average Channel Name specifies a user definable string that is used to help identify the channel or its function.

LOGIC 1-4, F321-F324

Attribute	Data Type	Access	Storage	Default	Description
A1	DF	RW	NRAM	0	Input Attribute 1 specifies the attribute associated with the first input channel.
A2	DF	RW	NRAM	0	Input Attribute 2 specifies the attribute associated with the second input channel.
A3	DF	RW	NRAM	0	Input Attribute 3 specifies the attribute associated with the third input channel.
A4	DF	RW	NRAM	0	Input Attribute 4 specifies the attribute associated with the fourth input channel.
A5	DF	RW	NRAM	0	Input Attribute 5 specifies the attribute associated with the fifth input channel.
A6	DF	RW	NRAM	0	Input Attribute 6 specifies the attribute associated with the sixth input channel.
A7	DF	RW	NRAM	0	Input Attribute 7 specifies the attribute associated with the seventh input channel.
A8	DF	RW	NRAM	0	Input Attribute 8 specifies the attribute associated with the eighth input channel.
CV	FE	RO	RAM	0	Current Value indicates the result after the operand specified in OP has been applied to the inputs.
DT	FE	RW	NRAM	253	PUP Datatype for Values specifies the PUP datatype for CV .
I1	DF	RW	NRAM	0	Input channel 1 specifies the first input channel.
I2	DF	RW	NRAM	0	Input channel 2 specifies the second input channel.
I3	DF	RW	NRAM	0	Input channel 3 specifies the third input channel.
I4	DF	RW	NRAM	0	Input channel 4 specifies the fourth input channel.
I5	DF	RW	NRAM	0	Input channel 5 specifies the fifth input channel.
I6	DF	RW	NRAM	0	Input channel 6 specifies the sixth input channel.
I7	DF	RW	NRAM	0	Input channel 7 specifies the seventh input channel.
I8	DF	RW	NRAM	0	Input channel 8 specifies the eighth input channel.
ON	DF	RW	NRAM	"Logic n" where n=1 to 4	Logic Channel Name specifies a user definable string that is used to help identify the channel or its function.

Attribute	Data Type	Access	Storage	Default	Description
OP	FE	RW	NRAM	0	Operation specifies the logic operation to be performed on the selected channels. 0=Disabled 1=OR 2=AND 3=NOT 4=XOR

PROGRAM SUMMARY, F200

Attribute	Data Type	Access	Storage	Default	Description
\$1	FE	RW	NRAM	0	<p>Program 1 Status indicates the current status of the resident SPL program number 1.</p> <p>0=Stop 1=Run 2=Unloaded 3=Abort 4=Wait for Time 5=Restart 6=Load 7=Unload Request 8=Abort Request 9=Wait for Fetch</p>
\$2	FE	RW	NRAM	0	<p>Program 2 Status indicates the current status of the resident SPL program number 2.</p> <p>0=Stop 1=Run 2=Unloaded 3=Abort 4=Wait for Time 5=Restart 6=Load 7=Unload Request 8=Abort Request 9=Wait for Fetch</p>
\$3	FE	RW	NRAM	0	<p>Program 3 Status indicates the current status of the resident SPL program number 3.</p> <p>0=Stop 1=Run 2=Unloaded 3=Abort 4=Wait for Time 5=Restart 6=Load 7=Unload Request 8=Abort Request 9=Wait for Fetch</p>
\$4	FE	RW	NRAM	0	<p>Program 4 Status indicates the current status of the resident SPL program number 4.</p> <p>0=Stop 1=Run 2=Unloaded 3=Abort 4=Wait for Time 5=Restart 6=Load 7=Unload Request 8=Abort Request 9=Wait for Fetch</p>
\$5	FE	RW	NRAM	0	<p>Program 5 Status indicates the current status of the resident SPL program number 6.</p> <p>0=Stop 1=Run 2=Unloaded 3=Abort 4=Wait for Time 5=Restart 6=Load 7=Unload Request 8=Abort Request 9=Wait for Fetch</p>

Attribute	Data Type	Access	Storage	Default	Description
\$6	FE	RW	NRAM	0	<p>Program 6 Status indicates the current status of the resident SPL program number 6.</p> <p>0=Stop 1=Run 2=Unloaded 3=Abort 4=Wait for Time 5=Restart 6=Load 7=Unload Request 8=Abort Request 9=Wait for Fetch</p>
\$7	FE	RW	NRAM	0	<p>Program 7 Status indicates the current status of the resident SPL program number 7.</p> <p>0=Stop 1=Run 2=Unloaded 3=Abort 4=Wait for Time 5=Restart 6=Load 7=Unload Request 8=Abort Request 9=Wait for Fetch</p>
\$8	FE	RW	NRAM	0	<p>Program 8 Status indicates the current status of the resident SPL program number 8.</p> <p>0=Stop 1=Run 2=Unloaded 3=Abort 4=Wait for Time 5=Restart 6=Load 7=Unload Request 8=Abort Request 9=Wait for Fetch</p>
ON	DF	RW	NRAM	"Program Summary"	<p>Program Summary Name specifies a user definable string that is used to help identify the channel or its function.</p>

PROGRAMS 1-8, F201-F208

Attribute	Data Type	Access	Storage	Default	Description
\$\$	FE	RW	NRAM	0	<p>Current Status indicates the current status of the resident SPL program.</p> <p>0=Stop 1=Run 2=Unloaded 3=Abort 4=Wait for Time 5=Restart 6=Load 7=Unload Request 8=Abort Request 9=Wait for Fetch</p>
\$1	FE	RW	NRAM	0	<p>Enable Single-Step Mode? specifies whether the single-step, line by line debugging mode is enabled.</p> <p>0=No 1=Yes</p>
\$C	FE	RO	NRAM	0	<p>Program Counter indicates the hexadecimal memory location of the next program statement to be executed.</p>
\$D	FE	RW	NRAM	0	<p>Delay Time Remaining specifies the number of seconds remaining when an SWAIT or MWAIT statement is encountered in the SPL program.</p>
\$E	FE	RW	NRAM	0	<p>Error Code indicates the SPL error code that is returned when the program aborts.</p>
\$S	FE	RW	NRAM	0	<p>Section Number indicates the current section number as determined by the SECTION statements in the SPL code.</p>
\$W	FE	RO	NRAM	0	<p>Trappable Error Action specifies how the SPL program should handle trappable errors.</p> <p>0=Abort on Error 1=Wait on Error</p>
%A	FE	RW	NRAM	0	<p>Register A Value indicates the value of program register A.</p>
%B	FE	RW	NRAM	0	<p>Register B Value indicates the value of program register B.</p>
%C	FE	RW	NRAM	0	<p>Register C Value indicates the value of program register C.</p>
%D	FE	RW	NRAM	0	<p>Register D Value indicates the value of program register A.</p>
%E	FE	RW	NRAM	0	<p>Register E Value indicates the value of program register E.</p>
%F	FE	RW	NRAM	0	<p>Register F Value indicates the value of program register F.</p>
%G	FE	RW	NRAM	0	<p>Register G Value indicates the value of program register G.</p>

Attribute	Data Type	Access	Storage	Default	Description
%H	FE	RW	NRAM	0	Register H Value indicates the value of program register H.
%I	FE	RW	NRAM	0	Register I Value indicates the value of program register I.
%J	FE	RW	NRAM	0	Register J Value indicates the value of program register J.
%K	FE	RW	NRAM	0	Register K Value indicates the value of program register K.
%L	FE	RW	NRAM	0	Register L Value indicates the value of program register L.
%M	FE	RW	NRAM	0	Register M Value indicates the value of program register M.
%N	FE	RW	NRAM	0	Register N Value indicates the value of program register N.
%O	FE	RW	NRAM	0	Register O Value indicates the value of program register O.
%P	FE	RW	NRAM	0	Register P Value indicates the value of program register P.
ON	DF	RW	NRAM	"Program n" where n=1 to 8	Program Name specifies a user definable string that is used to help identify the channel or its function.

INPUT SELECT 1-4, F011-F014

Attribute	Data Type	Access	Storage	Default	Description
A1	DF	RW	NRAM	0	Input Attribute 1 specifies the attribute associated with the first input channel.
A2	DF	RW	NRAM	0	Input Attribute 2 specifies the attribute associated with the second input channel.
CV	FE	RO	RAM	0	Current Value
DT	FE	RW	NRAM	0	PUP Data Type for Values specifies the PUP datatype for CV.
I1	DF	RW	NRAM		Input channel 1 specifies the first input channel.
I2	DF	RW	NRAM		Input channel 2 specifies the second input channel.
ON	DF	RW	NRAM	"Input Select n" where n=1 to 4	Input Select Name specifies a user definable string that is used to help identify the channel or its function.
SA	FE	RW	NRAM	0	Selection Attribute specifies the attribute associated with the selection channel used as the selection criteria.
SC	FE	RW	NRAM	0	Selection Channel specifies the channel used as the selection criteria.

BROADCAST 0, F000

Attribute	Data Type	Access	Storage	Default	Description
BE	FE	RW	NRAM	0	Broadcast Enable specifies whether the controller should broadcast the value of CV over the network. 0=No 1=Yes
BZ	FE	RW	NRAM	1	Broadcast Zone/Global specifies whether the controller's broadcasts are sent to the zone or broadcast globally. 0=Zone broadcast 1=Global broadcast
CV	FB	RW	RAM		Current Value indicates the current value of the referenced channel specified in IC.
DT	FE	RW	NRAM	253	PUP Data Type for Values specifies the PUP datatype for the broadcast.
IA	DF	RW	NRAM	0	Input Attribute specifies the attribute associated with the channel specified in IC to be broadcast.
IC	DF	RW	NRAM		Input Channel specifies the input channel to be broadcast.
ON	DF	RW	NRAM	Broadcast Outside Air Temp	Broadcast Name specifies a user definable string that is used to help identify the channel or its function.
RB	FE	RW	NRAM		Receive Broadcast? specifies that the controller should accept broadcasted values for CV for the channel and attribute specified in IC and IA respectively.

BROADCAST 1, F001

Attribute	Data Type	Access	Storage	Default	Description
BE	FE	RW	NRAM	0	Broadcast Enable specifies whether the controller should broadcast the value of CV over the network. 0=No 1=Yes
BZ	FE	RW	NRAM	1	Broadcast Zone/Global specifies whether the controller's broadcasts are sent to the zone or broadcast globally. 0=Zone broadcast 1=Global broadcast
CV	FB	RW	RAM		Current Value indicates the current value of the referenced channel specified in IC.
DT	FE	RW	NRAM	253	PUP Data Type for Values specifies the PUP datatype for the broadcast.
IA	DF	RW	NRAM	0	Input Attribute specifies the attribute associated with the channel specified in IC to be broadcast.
IC	DF	RW	NRAM		Input Channel specifies the input channel to be broadcast.
ON	DF	RW	NRAM	Broadcast Outside Air Humidity	Broadcast Name specifies a user definable string that is used to help identify the channel or its function.
RB	FE	RW	NRAM		Receive Broadcast? specifies that the controller should accept broadcasted values for CV for the channel and attribute specified in IC and IA respectively.

BROADCAST 2, F002

Attribute	Data Type	Access	Storage	Default	Description
BE	FE	RW	NRAM	0	Broadcast Enable specifies whether the controller should broadcast the value of CV over the network. 0=No 1=Yes
BZ	FE	RW	NRAM	1	Broadcast Zone/Global specifies whether the controller's broadcasts are sent to the zone or broadcast globally. 0=Zone broadcast 1=Global broadcast
CE	FE	RW	NRAM	0	Enthalpy Calculation Enable enabled the calculation and broadcast the outside air enthalpy
CV	FB	RW	RAM		Current Value indicates the current value of the referenced channel specified in IC.
DT	FE	RW	NRAM	253	PUP Data Type for Values specifies the PUP datatype for the broadcast.
IA	DF	RW	NRAM	0	Input Attribute specifies the attribute associated with the channel specified in IC to be broadcast.
IC	DF	RW	NRAM		Input Channel specifies the input channel to be broadcast.
ON	DF	RW	NRAM	Broadcast Enthalpy	Broadcast Name specifies a user definable string that is used to help identify the channel or its function.
RB	FE	RW	NRAM		Receive Broadcast? specifies that the controller should accept broadcasted values for CV for the channel and attribute specified in IC and IA respectively.

BROADCAST 3, F003

Attribute	Data Type	Access	Storage	Default	Description
BE	FE	RW	NRAM	0	Broadcast Enable specifies whether the controller should broadcast the value of CV over the network. 0=No 1=Yes
BZ	FE	RW	NRAM	1	Broadcast Zone/Global specifies whether the controller's broadcasts are sent to the zone or broadcast globally. 0=Zone broadcast 1=Global broadcast
CV	FB	RW	RAM		Current Value indicates the current value of the referenced channel specified in IC.
DT	FE	RW	NRAM	253	PUP Data Type for Values specifies the PUP datatype for the broadcast.
IA	DF	RW	NRAM	0	Input Attribute specifies the attribute associated with the channel specified in IC to be broadcast.
IC	DF	RW	NRAM		Input Channel specifies the input channel to be broadcast.
ON	DF	RW	NRAM	Broadcast 3	Broadcast Name specifies a user definable string that is used to help identify the channel or its function.
RB	FE	RW	NRAM		Receive Broadcast? specifies that the controller should accept broadcasted values for CV for the channel and attribute specified in IC and IA respectively.

BROADCAST 4, F004

Attribute	Data Type	Access	Storage	Default	Description
BE	FE	RW	NRAM	0	Broadcast Enable specifies whether the controller should broadcast the value of CV over the network. 0=No 1=Yes
BZ	FE	RW	NRAM	1	Broadcast Zone/Global specifies whether the controller's broadcasts are sent to the zone or broadcast globally. 0=Zone broadcast 1=Global broadcast
CV	FB	RW	RAM		Current Value indicates the current value of the referenced channel specified in IC.
DT	FE	RW	NRAM	253	PUP Data Type for Values specifies the PUP datatype for the broadcast.
IA	DF	RW	NRAM	0	Input Attribute specifies the attribute associated with the channel specified in IC to be broadcast.
IC	DF	RW	NRAM		Input Channel specifies the input channel to be broadcast.
ON	DF	RW	NRAM	Broadcast 4	Broadcast Name specifies a user definable string that is used to help identify the channel or its function.
RB	FE	RW	NRAM		Receive Broadcast? specifies that the controller should accept broadcasted values for CV for the channel and attribute specified in IC and IA respectively.

BROADCAST 5, F005

Attribute	Data Type	Access	Storage	Default	Description
BE	FE	RW	NRAM	0	Broadcast Enable specifies whether the controller should broadcast the value of CV over the network. 0=No 1=Yes
BZ	FE	RW	NRAM	1	Broadcast Zone/Global specifies whether the controller's broadcasts are sent to the zone or broadcast globally. 0=Zone broadcast 1=Global broadcast
CV	FB	RW	RAM		Current Value indicates the current value of the referenced channel specified in IC.
DT	FE	RW	NRAM	253	PUP Data Type for Values specifies the PUP datatype for the broadcast.
IA	DF	RW	NRAM	CV	Input Attribute specifies the attribute associated with the channel specified in IC to be broadcast.
IC	DF	RW	NRAM	F900	Input Channel specifies the input channel to be broadcast.
ON	DF	RW	NRAM	Broadcast Schedule	Broadcast Name specifies a user definable string that is used to help identify the channel or its function.
RB	FE	RW	NRAM		Receive Broadcast? specifies that the controller should accept broadcasted values for CV for the channel and attribute specified in IC and IA respectively.

BROADCAST 6, F006

Attribute	Data Type	Access	Storage	Default	Description
BE	FE	RW	NRAM		Broadcast Enable specifies whether the controller should broadcast the value of CV over the network. 0=No 1=Yes
BZ	FE	RW	NRAM	1	Broadcast Zone/Global specifies whether the controller's broadcasts are sent to the zone or broadcast globally. 0=Zone broadcast 1=Global broadcast
CV	FB	RW	RAM		Current Value indicates the current value of the referenced channel specified in IC.
DT	FE	RW	NRAM	253	PUP Data Type for Values specifies the PUP datatype for the broadcast.
IA	DF	RW	NRAM	0	Input Attribute specifies the attribute associated with the channel specified in IC to be broadcast.
IC	DF	RW	NRAM		Input Channel specifies the input channel to be broadcast.
ON	DF	RW	NRAM	Broadcast 6	Broadcast Name specifies a user definable string that is used to help identify the channel or its function.
RB	FE	RW	NRAM		Receive Broadcast? specifies that the controller should accept broadcasted values for CV for the channel and attribute specified in IC and IA respectively.

BROADCAST 7, F007

Attribute	Data Type	Access	Storage	Default	Description
BE	FE	RW	NRAM	0	Broadcast Enable specifies whether the controller should broadcast the value of CV over the network. 0=No 1=Yes
BZ	FE	RW	NRAM	1	Broadcast Zone/Global specifies whether the controller's broadcasts are sent to the zone or broadcast globally. 0=Zone broadcast 1=Global broadcast
CV	FB	RW	RAM		Current Value indicates the current value of the referenced channel specified in IC.
DT	FE	RW	NRAM	253	PUP Data Type for Values specifies the PUP datatype for the broadcast.
IA	DF	RW	NRAM	0	Input Attribute specifies the attribute associated with the channel specified in IC to be broadcast.
IC	DF	RW	NRAM		Input Channel specifies the input channel to be broadcast.
ON	DF	RW	NRAM	Broadcast 7	Broadcast Name specifies a user definable string that is used to help identify the channel or its function.
RB	FE	RW	NRAM		Receive Broadcast? specifies that the controller should accept broadcasted values for CV for the channel and attribute specified in IC and IA respectively.

APPENDIX B: SPL ERROR CODES

This section lists the possible error codes that can be generated by a running SPL program.

Code	Trappable	Meaning	Possible Causes/Examples
1	x	Invalid Request	An unsupported math function was requested by the program.
5	x	Timeout	Too much time (i.e., more than 20 ms) was taken to execute the "once-per-second" routine.
7	x	NAK Response	The program tried to write a value to a read-only attribute.
8	x	Invalid Channel #	A read/write request was made to an unknown or non-existent channel.
9	x	No Such Attribute	A read/write request was made to an unknown or non-existent attribute.
59	✓	Alarm Queue Failure	The alarm queue is full (i.e., it has more than 3 alarms and has not been polled).
62	x	Conversion Error	An invalid data type conversion was attempted. For example, trying to assign a negative value to an attribute that has been defined as a BCD time data type would cause a conversion error.
63	x	Underflow Error	The result of a subtraction function resulted in a value that could not be represented in 32 bits.
64	x	Overflow Error	The result of an addition function resulted in a value that could not be represented in 32 bits.
65	x	Not a Number	The square root (SQRT function) of a negative number was attempted.
66	x	Invalid Format	The result of a report generation using a non-ASCII data file.
67	x	Invalid Data Type	The result of RETYPEing an attribute using an invalid or nonexistent data type code.
128	x	Invalid Program Register	The result of accessing program register %P, for example, from the once-per-second routine (which does not have a %P register).
130	x	Stack Error	The result of having an excessive number of nested expressions.
131	x	Invalid Program Code	The result of trying to run a program intended for a different controller on a GPC platform, or if the GPC executor encountered unrecognized program logic.

Code	Trappable	Meaning	Possible Causes/Examples
132	x	Invalid Term	This occurs when a mathematical calculation or function yields a result (typically a data type) that is not the expected result (e.g., an unexpected data type). For example, if the result of a mathematical operation was something other than an unsigned integer (when an unsigned integer result was expected), an invalid term error would be generated.
133	x	Invalid Operator	A math operator that is unsupported by the SOLO/GX was encountered during the execution of the program code.
134	x	Invalid State	This occurs if the program code (PCB) or RAM gets corrupted.
146	x	Invalid Index	A program statement attempted to access a table element whose index exceeded the size of the table.

APPENDIX C: PUP DATA TYPES

This Appendix lists the hexadecimal and decimal PUP numeric data type codes. The hexadecimal codes are followed by h and the decimal codes are provided in parentheses.

Code	Digit Format	Meaning
FFh (255)	±XXXXXXXXXX.	signed 10 digit
FEh (254)	XXXXXXXXXX.	unsigned 10 digit
FDh (253)	±XXXXXXXXX.X	signed 9.1 digit
FCh (252)	XXXXXXXXX.X	unsigned 9.1 digit
FBh (251)	±XXXXXXXX.XX	signed 8.2 digit
FAh (250)	XXXXXXXX.XX	unsigned 8.2 digit
F9h (249)	±XXXXXXX.XXX	signed 7.3 digit
F8h (248)	XXXXXXX.XXX	unsigned 7.3 digit
F7h (247)	±XXXXXX.XXXX	signed 6.4 digit
F6h (246)	XXXXXX.XXXX	unsigned 6.4 digit
F5h (245)	±XXXXX.XXXXX	signed 5.5 digit
F4h (244)	XXXXX.XXXXX	unsigned 5.5 digit
F3h (243)	±XXXX.XXXXXX	signed 4.6 digit
F2h (242)	XXXX.XXXXXX	unsigned 4.6 digit
F1h (241)	±XXX.XXXXXXX	signed 3.7 digit
F0h (240)	XXX.XXXXXXX	unsigned 3.7 digit
EFh (239)	±XX.XXXXXXXXX	signed 2.8 digit
EEh (238)	XX.XXXXXXXXX	unsigned 2.8 digit
EDh (237)	±X.XXXXXXXXXX	signed 1.9 digit
ECh (236)	X.XXXXXXXXXX	unsigned 1.9 digit
EBh (235)	±.XXXXXXXXXXX	signed .10 digit
EAh (234)	.XXXXXXXXXXX	unsigned .10 digit
E9h (233)	channel map	one bit per channel

Code	Digit Format	Meaning
E8h (232)	bitmap of text	one bit per text field
E7h (231)	BCD (H/S/M)	hours is LSB
E6h (230)	BCD (H/M)	hours is LSB
E5h (229)	packed BCD	8 BCD digits as 4 bytes
E4h (228)	BCD date (Y/M/D)	MSW is year LSW/MSB is month LSW/LSB is day
E3h (227)	Binary date	MSW is year LSW/MSB is month LSW/LSB is day
E2h (226)	reserved	
E1h (225)	reserved	
E0h (224)	IEEE 754 32-bit floating point	
DFh-00h (223-0)	reserved	